

ELEVATORS

Adson Periosteal Elevator

- 16cm/6¼" length
- Curved blunt

	Width
OR 3052-16	2 mm
OR 3055-16	5 mm
OR 3007-16	7 mm
OR 3054-16	4 mm



Pennybacker Periosteal Elevator

- 16cm/6¼" length
- Curved sharp

	Width
OR3064-16	4mm
OR3066-16	6mm
OR3068-16	8mm



Bone Raspatory with Tufnol Handle

- 19cm/7½" length



Straight	Width
OR7016-19	6mm
Conical Straight	
OR 7015-14	

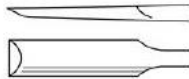

Curved	Width
OR7023-19	3mm
OR7026-19	6mm
Conical Curved	
OR 7015-14	

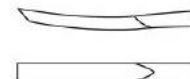

Farabeuf Rugine Elevator

- 15cm/6" length

Straight	Width
OR 3001-15	12 mm
OR 3001-05	5 mm
Curved*	Width
OR 3002-15	12 mm
OR 3002-05	5 mm



*illustrated

Farabeuf Rugine Elevator with Hollow Handle

- 16cm/6¼" length

Straight	Width
OR3011-16	12mm
Curved*	Width
OR3012-16	12mm



*illustrated

Key Elevator

- 18cm/7" length

OR 874	6 mm
OR 875	12 mm
OR 876	19 mm
OR 877	25 mm



Trethowan Bone Elevator

- 22.5cm/8½" length

OR3030-22



Lanes Bone Elevator

- 26cm/10" length

OR3031-26



Fagge Bone Elevator

- 27.5cm/10¾" length

OR3032-27



Bristow Periosteal Elevator

- 23cm/9" length
- Curved sharp
- 10mm width

OR 3003-10

- 15mm width

OR 3003-15



Femoral Dislocation Lever

- 31cm/12½" length
- 26mm width

OR3026-31



Muller Femoral Retractor

- 35cm/13½" length
- 28mm width

OR3028-35



For retraction of the femoral neck.

STANDARD ✦ **DELUXE** ≡ *Premium*

COMPLETE RANGE OF SURGICAL INSTRUMENTS SINCE 1925

Mini Bone Lever

- 14cm/5½"
- 2.8mm width

OR5830-14



Hohmann Style Mini-Bone Lever

- 16cm/6¼"
- 6mm width

OR5831-16



Phalangeal Lever

- 15cm/6"
- 5mm width

OR5832-16



Buck-Gramcko Lever

- 15cm/6"
- 7.5mm width

OR5833-15



Mini-Cobra Bone Lever

- 16cm/6¼"
- 15mm width

OR5834-16



McGlamry Metatarsal Elevator

- 17cm/6½"
- Sharp

	Width
OR5835-10	9mm
OR5835-12	11mm
OR5835-14	13mm
OR5835-16	15mm
OR5835-19	19mm



Hohmann Bone Elevator

- 22cm/8½" length

	width
OR 3009-08	8 mm
OR 3009-10	10 mm
OR 3009-15	15 mm



Hohmann Bone Elevator

- 24cm/9½" length

	width
OR 3018-17	17 mm
OR 3018-22	22 mm



Hohmann Bone Elevator

- 24cm/9½" length

	width
OR 3043-33	33 mm
OR 3043-35	35 mm
OR 3043-44	44 mm

- 28cm/ 11" length

	width
OR 3033-33	33 mm
OR 3033-44	44 mm



Hohmann Large Bone Elevator

- 24cm/9½" length
- 70mm width

OR 3012-70



Hohmann Bone Elevator Blunt

- 28cm/11" length
- 35 mm width

OR 3033-35



Hohmann Bone Elevator

- 26cm/10" length
- 24mm width

OR3024-24



Bone Hook Sharp

- 24.5cm/9¾" length
- Sharp

OR9050-24



Blunt Hook

- 20cm/8" length

OR9051-20



Wroblenski Dislocating Hook

- 25cm/10" length
- For hooking around the neck of the Femur

OR9055-25



Bohler Bone Cutters

- 15cm/6" length
- Double action

Straight
OR5160-50

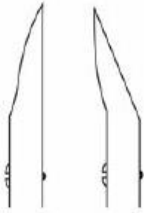

Angled
OR5161-50



McIndoe Bone Cutters

- 18cm/7" length
- Double action
- Angled jaws



OR1028-18



Ruskin-Liston Bone Cutters

- 19cm/7½" length
- Double action



Straight
OR5170-19



Angled
OR5171-19



Stille-Liston Bone Cutters

- 27cm/10¾" length
- Double action



Straight
OR1024-27



Angled
OR1025-27

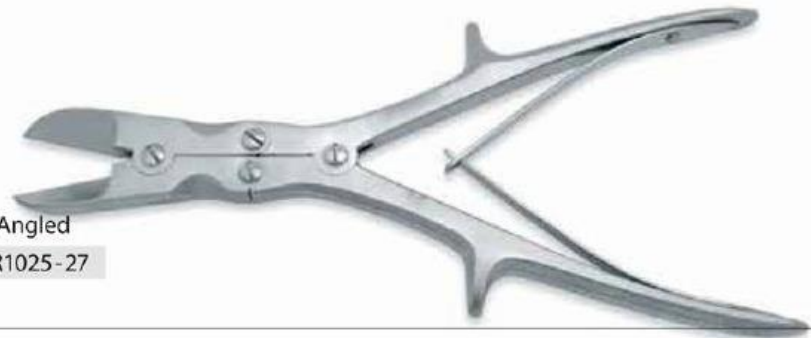

Liston-Key-Horsley Bone Cutters

- 27cm/10¾" length
- Double action
- Angled



OR1023-27



STANDARD ♦ **DELUXE** ≡ *Premium*

COMPLETE RANGE OF SURGICAL INSTRUMENTS SINCE 1925

Bohler Bone Nibbler

- Curved double action
- 15cm/6"

3mm Bite

OR5120-50



Marquardt Bone Nibbler

- 20cm/8" length
- Curved double action

3mm Bite

OR1002-20



Beyer Bone Nibbler

- Curved double action
- 18cm/7"

4mm Bite

OR1002-18



20cm/8" curved

OR1001-20

20cm/8" straight

OR1002-20



Jansen Bone Nibbler

- Curved double action
- 18cm/7"

5mm Bite

OR1003-18

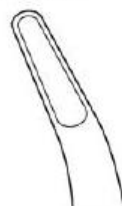

18cm/7" Straight

OR1103-18



Smith-Peterson Bone Nibbler

- 24cm/9½" length
- Double action

Straight	Light Curve	Bite Size
OR1010-24	OR1014-24	3mm
OR1011-24	OR1015-24	4mm
OR1012-24	OR1016-24	5mm
OR1013-24	OR1017-24	6mm

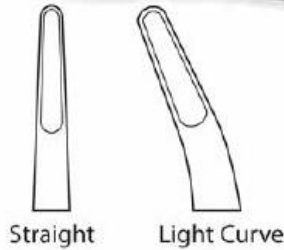

Leksell Bone Nibbler

- 24cm/9½" length
- Double action angled

Angled Jaw	Bite Size
OR1018-24	3mm
OR1019-24	5mm
OR1020-24	8mm

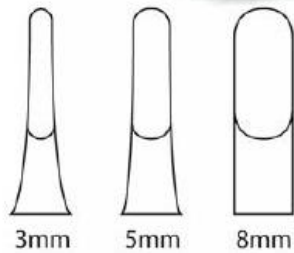

Stille-Luer Bone Nibbler

- 22cm/8¾" length
- Double action

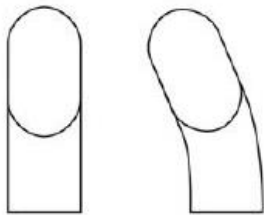

Straight 10mm Bite	OR1006-22
Curved 10mm Bite	OR1007-22



27cm/10 1/2" Straight	OR1006-27
27cm/10 1/2" curved	OR1007-27

Semb Bone Nibbler

- 26cm/10¼" length
- Double action

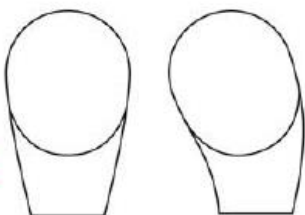

Straight 17mm Bite	OR1008-26
Curved 17mm Bite	OR1009-26



Pattela Holding Forceps

- with smart lock

OR 00363



Frosch Bone Holding Forceps

- 18cm/7" length
- Toothed/serrated jaws

OR6141-18



Two Pointed Reduction Clamp

- 14cm/ 5 1/5"

HF 5042-14

- 19cm/ 7 1/5"

HF 5042-19

- 23cm/ 9"

HF 5042-23

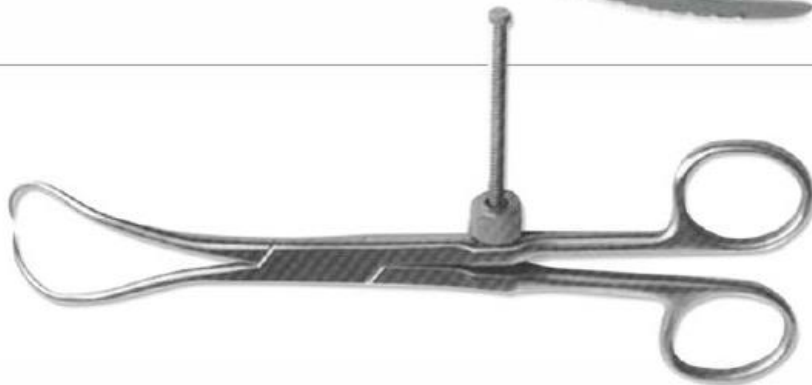

Fergusson Bone Holding Forceps

- 20cm/8" length
- Screw joint

OR6140-20



Langenbeck Bone Holding Forceps

- 21cm/8¼" length

OR6144-21



Semb Bone Holding Forceps

- 19cm/7½" length
- Angled to side

OR6147-18



Hey Groves Bone Holding Forceps

- Screw joints
- Serrated jaws



Length

OR6145-20	20cm/8"	Small
OR6145-25	25.5cm/10"	Medium
OR6145-30	30.5cm/12"	Large

Verbrugge Bone Holding Forceps



Length

OR6150-25	25cm/10"	Small
OR6150-26	26cm/10½"	Medium
OR6150-27	27cm/11"	Large

Self Centering Bone Holding Forceps

OR 6149-16	16cm 6 1/2"
OR 6149-19	19cm 7 1/2"
OR 6149-22	22cm 8 1/2"
OR 6149-24	24cm 9 1/2"
OR 6149-27	27cm 10 1/2"
OR 6149-29	29cm 11 1/2"

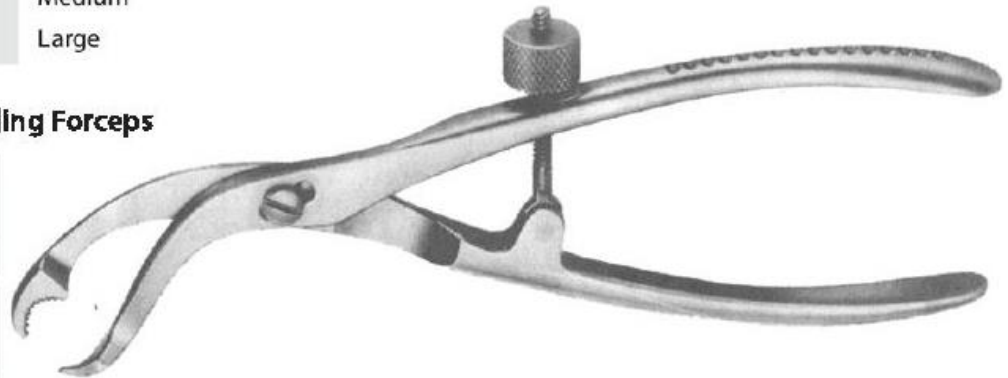

STANDARD ✦ **DELUXE** ≡ *Premium*

COMPLETE RANGE OF SURGICAL INSTRUMENTS SINCE 1925

Pelvic Reduction Forceps

- 19cm/7½" length
- Angled, small
- Pointed ball tips
- Speed lock

OR6151-19



Pelvic Reduction Forceps

- 23cm/9" length
- Angled, large
- Pointed ball tips
- Speed lock

OR6152-23



Pelvic Reduction Forceps

- 25cm/10" length
- Straight, large
- Pointed ball tips
- Speed lock

OR6153-25



Pelvic Reduction Forceps

- 40cm/16" length
- Pointed ball tips
- Speed lock

OR6154-40



STANDARD ✦ **DELUXE** ≡ *Premium*

COMPLETE RANGE OF SURGICAL INSTRUMENTS SINCE 1925

Asymmetric Pelvic Reduction Forceps

• 40cm/16" length

OR 615640

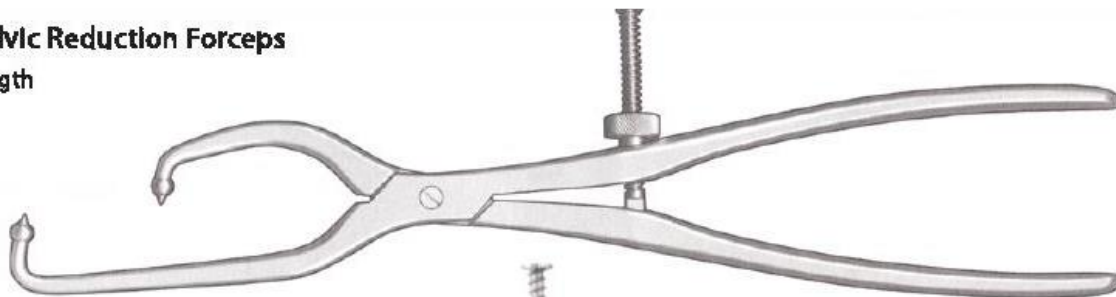

Pelvic Reduction Forceps with Screws

• 34cm/13 1/2" length

OR 615740



Spanish Bone Reduction Forceps

• 17cm/6 1/2" length

OR 5024-17

• 19cm/7 1/2" length

OR 5024-19

• 24cm/9 1/2" length

OR 5024-24

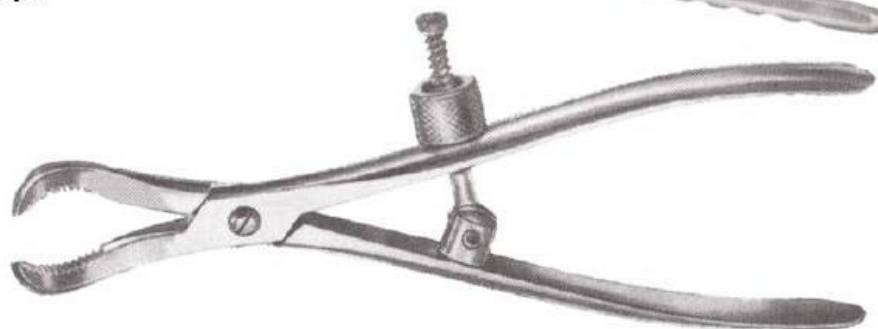

Lowman Bone Holding Forceps

• 14cm/5 1/2" length

OR 6180-14

• 18cm/7" length

OR 6180-18

• 20cm/8" length

OR 6180-20

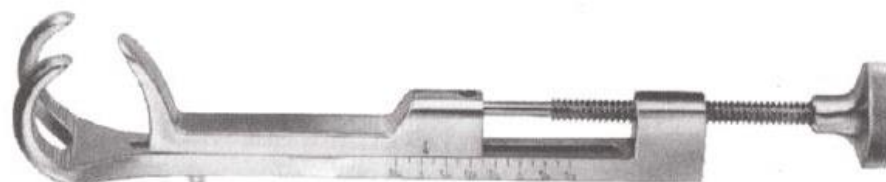

Weitlaner S/R Retractor

- 14cm/5½" length
- 3x4 Blunt prongs

OR4002-14

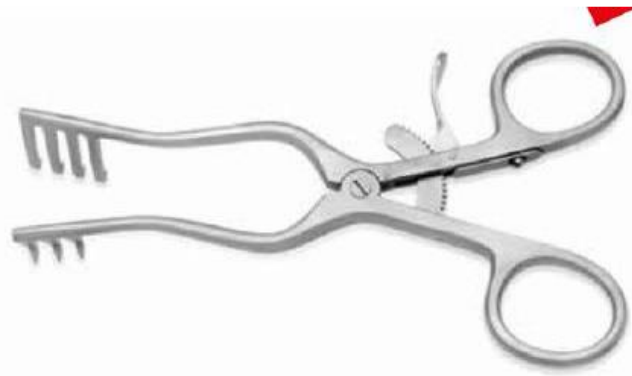

Travers S/R Retractor

- 20cm/8" length
- 4x5 Blunt prongs

OR4004-20



Norfolk and Norwich S/R Retractor

- 20cm/8" length
- 4x5 Blunt prongs

OR4000-20



Gelpi Laminectomy Retractor

- Sharp prongs

	Length	Prong depth
OR4030-16	18.5cm/7¼"	30mm
OR4050-16	19.5cm/7¾"	50mm
OR4070-16	20cm/8"	70mm



Charnley Vertical Retractor

- 24.5cm/9½" length
- 3x4 Sharp prongs
- Blade depth 22mm

OR4007-24



**Beckman-Weitlaner/
Cones Self Retaining Retractor**

- 3x4 Prongs
- Jointed arms

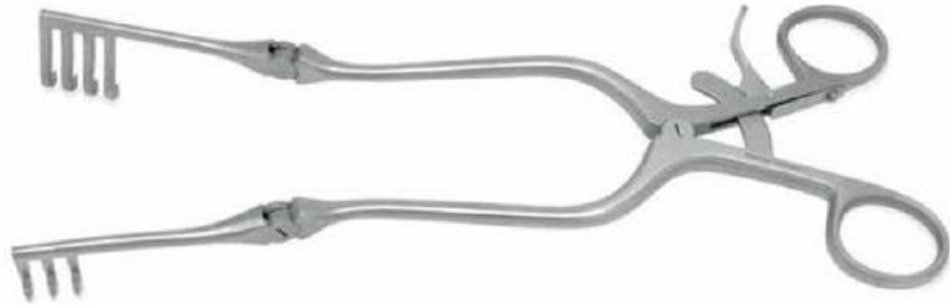

Blunt Prongs	Length	Depth	Sharp Prongs	Length	Depth
OR4064-13	13cm/5"	15mm	SP4063-13	13cm/5"	15mm
OR4066-16	16cm/6 ½"	15mm	SP4065-16	16cm/6 ½"	15mm
OR4068-20	20cm/8"	20mm	SP4067-20	20cm/8"	20mm
OR4070-24	24cm/9 ½"	25mm	SP4069-24	24cm/9 ½"	25mm

Harvey Jackson Self Retaining Retractor

- 30.5cm/12" length
- Blade depth 45mm
- 3x3 Sharp prongs

OR4010-30



STANDARD ✦ **DELUXE** ≡ *Premium*

COMPLETE RANGE OF SURGICAL INSTRUMENTS SINCE 1925

Mini-Lambotte Osteotome



12.5cm/5" length	Width	17.78cm/7" length	Width
OR 5205-02	2mm	OR 5207-02	2mm
OR 5205-03	3mm	OR 5207-03	3mm
OR 5205-04	4mm	OR 5207-04	4mm
OR 5205-06	6mm	OR 5207-06	6mm
OR 5205-08	8mm	OR 5207-08	8mm

Lambotte Osteotome

■ 25cm/9¾" length



Straight	Width	Curved	Width
OR7970-04	4mm	OR7971-04	4mm
OR7970-06	6mm	OR7971-06	6mm
OR7970-08	8mm	OR7971-08	8mm
OR7970-10	10mm	OR7971-10	10mm
OR7970-13	13mm	OR7971-13	13mm
OR7970-16	16mm	OR7971-16	16mm
OR7970-18	18mm	OR7971-18	18mm
OR7970-20	20mm	OR7971-20	20mm
OR7970-25	25mm	OR7971-25	25mm
OR7970-30	30mm	OR7971-30	30mm

Mini- Stille Osteotome

• 16cm/6¼" length

Straight	Width
OR7704-16	4mm
OR7706-16	6mm
OR7708-16	8mm



Stille (Swedish) Osteotome

• 20cm/8" length

Straight	Width	Curved	Width
OR 7708-06	6mm	OR 7608-06	6mm
OR 7708-08	8mm	OR 7608-08	8mm
OR 7708-10	10mm	OR 7608-10	10mm
OR 7708-12	12mm	OR 7608-12	12mm
OR 7708-15	15mm	OR 7608-15	15mm
OR 7708-20	20mm	OR 7608-20	20mm
OR 7708-25	25mm	OR 7608-25	25mm
OR 7708-30	30mm	OR 7608-30	30mm



Hibbs Osteotome with thin blade

• 20cm/8" length
• Extra thin blade

Straight	Width	Curved	Width
OR 7808-04	4mm	OR 7908-04	4mm
OR 7808-06	6mm	OR 7908-06	6mm
OR 7808-08	8mm	OR 7908-08	8mm
OR 7808-10	10mm	OR 7908-10	10mm
OR 7808-12	12mm	OR 7908-12	12mm
OR 7808-15	15mm	OR 7908-15	15mm
OR 7808-20	20mm	OR 7908-20	20mm
OR 7808-25	25mm	OR 7908-25	25mm
OR 7808-30	30mm	OR 7908-30	30mm



Smith Petersen Osteotome

• 20cm/8" length

	Width
OR7610-20	10mm
OR7615-20	15mm
OR7620-20	20mm
OR7625-20	25mm
OR7630-20	30mm



STANDARD ✦ **DELUXE** ≡ *Premium*

Lexer Osteotome

- 22cm/8½" length
- **Fibre handle**



	Width
OR7207-22	7mm
OR7210-22	10mm
OR7215-22	15mm
OR7220-22	20mm
OR7225-22	25mm

Dahmen Osteotome

- 30cm/12" length
- **Fibre handle**



	Width		Straight	Width		Angled	Width
	5mm		OR7105-30	5mm		OR7305-30	5mm
	10mm		OR7110-30	10mm		OR7310-30	10mm
	15mm		OR7115-30	15mm		OR7315-30	15mm
	20mm		OR7120-30	20mm		OR7320-30	20mm
	25mm		OR7125-30	25mm		OR7325-30	25mm
	30mm		OR7130-30	30mm		OR7330-30	30mm

Volkman Curette

- 22cm/8¾" length
- Double ended

	Size
OR8401-22	Small
OR8402-22	Medium
OR8403-22	Large

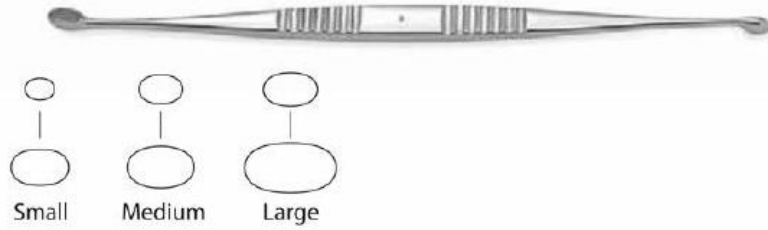

Muller Curette with Tufnol Handle

- 27cm/9¾" length
- Tufnol handle



Charnley Bone Curette

- 37cm/15" length
- T-handle



Charnley Ring Curette

- 37cm/15" length
- Double sided
- Serrated cutting edge
- T-handle



Cup Extraction Chisel

- 32cm/12½" length
- Curved 7mm tip
- Metal strike plate
- Tufnol handle



OR6507-32

Bayonet Gouge

- 32cm/12½" length
- Metal strike plate
- Tufnol handle
- 8mm width



OR6508-32

Swan Necked Gouge

- 28.5cm/11" length
- 25mm width



OR6525-28

Cement Gouge

- 34.5cm/13½" length



9mm width

SP6509-34

11mm width

SP6511-34

Cement Chisel Angled 15°

- 35.5cm/14 length
- 9mm tip



OR6109-35



Cement Osteotome

- 30cm/12" length
- Tufnol handle with strike plate

	Width
OR6105-30	5mm
OR6107-30	7mm
OR6110-30	10mm



Cement Splitting Osteotome

- 30cm/12" length
- Tufnol handle with strike plate
- Guarded blade

	Width
OR6205-30	5mm
OR6210-30	10mm



Straight Cement Gouge

- 30cm/12" length
- Tufnol handle with strike plate

	Width
OR6305-30	5mm
OR6307-30	7mm
OR6310-30	10mm



Bayonet Cement Rasp

- 52cm/20½" length
- Tufnol handle

*illustrated



OR6100-52  V-shape

OR6101-52  Strong round shape*

OR6102-52  Flat round curve

Bayonet Cement Chisel

- 40cm/15¾" length
- Tufnol handle with strike plate



Bayonet Cement Splitting Osteotome

- 40cm/15¾" length
- Tufnol handle with strike plate
- Guarded blade



Bayonet Cement Gouge

- 40cm/15¾" length
- Tufnol handle with strike plate



Bayonet Cement Gouge

- 40cm/15¾" length
- Tufnol handle with strike plate

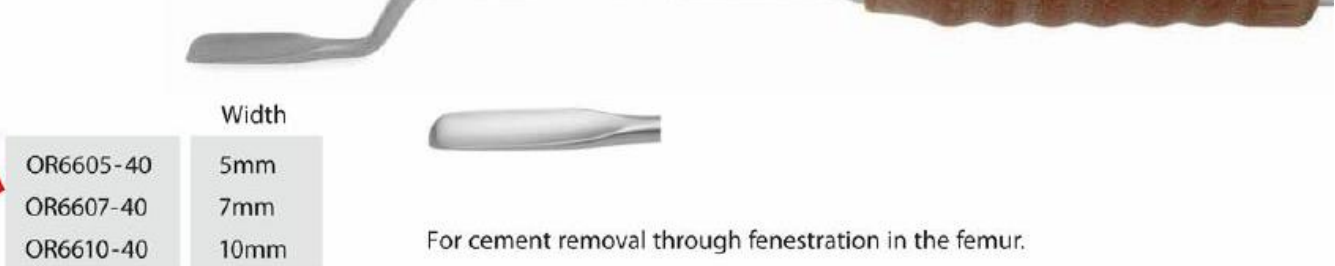

Malleable Cement Probe

- 38cm/15" length
- For probing the Femur



Cement Plug Extractor

- 48cm/19" length
- T-handle
- For extraction of cement plug

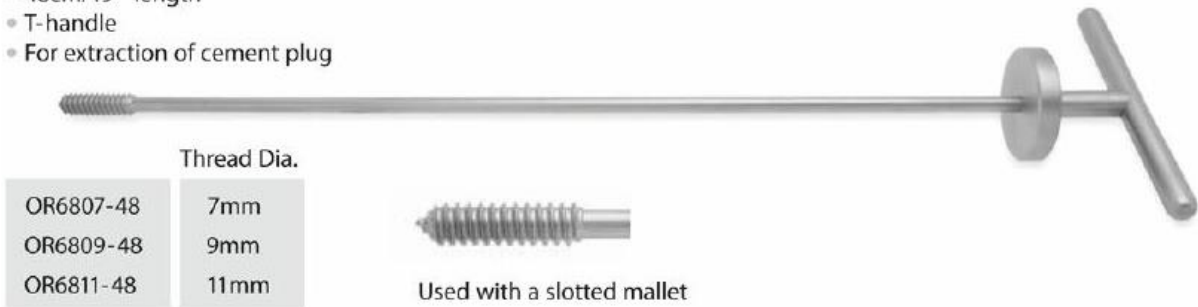

Retrograde Cement Chisel

- 50cm/19¾" length
- Tufnol T-handle
- Striking plate

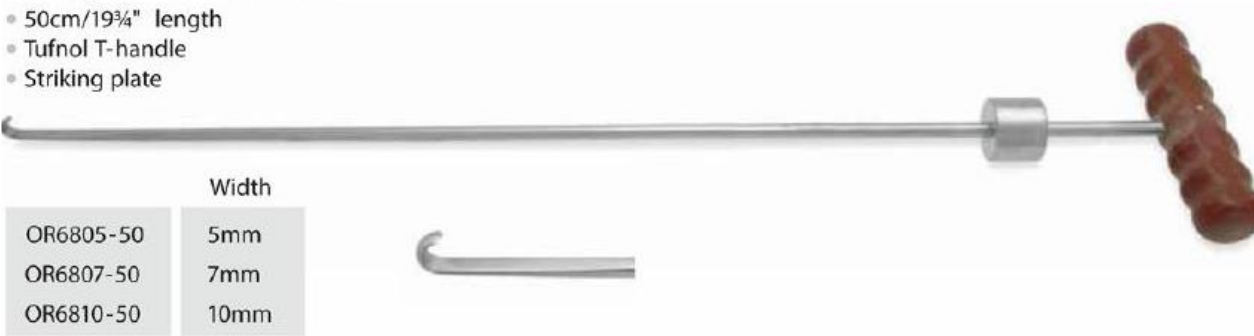

Slotted Mallet



Cement Extraction Hook

- 34.5cm/14" length

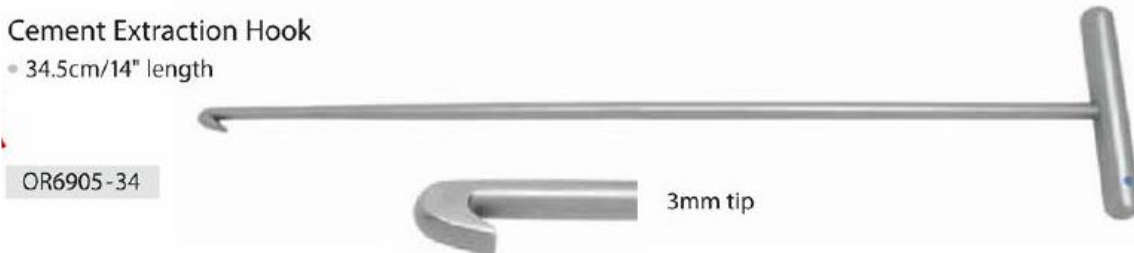

Muller Claus Wire Cutters

- 16cm/6" length
- Tungsten carbide edges
- Cuts wire up to 1.6mm Ø

8-810E16



Muller Claus Wire Cutters

- Tungsten carbide edges

8-810E18

- 18cm/7" length*
- Cuts wire up to 2mm Ø

8-800E22

- 22cm/8¾" length
- Cuts wire up to 3mm Ø



*illustrated

End Wire Cutters

- 18cm/7" length
- Tungsten carbide edges
- Cuts wire up to 1.7mm Ø

8-816E18



Bolt Cutters with dismantable arms

- Max. cap 6.3mm pins

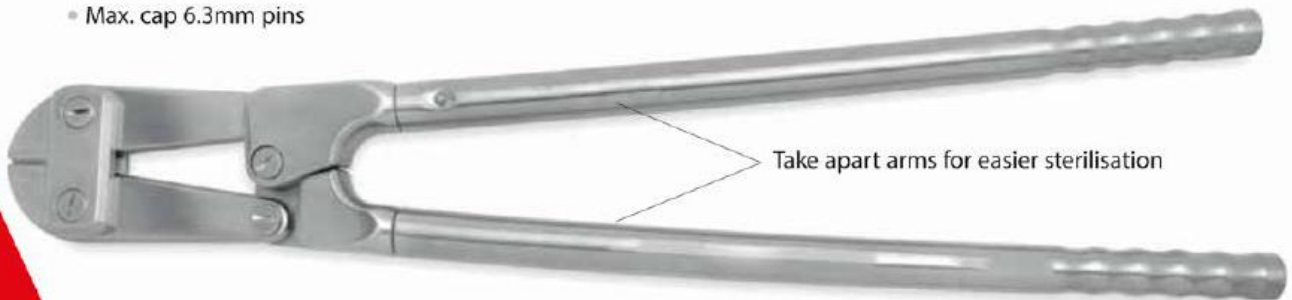

200-500-585

- Must be used in conjunction with a Rod Holder. Ordering Code: 200-675-200

Combined Wire Cutters & Pliers

- 18cm/7" length
- Suitable for wires up to 1.6mm Ø
- Parallel closing jaws

200-512-185



Wire Cutters with T/C Jaws

- 24cm/9½" length
- Double action
- Cuts plates & wires up to 2.7mm Ø

OR7644-24



Howarth Elevator

- 21.5cm/8½" length



PS 9207-21

MacDonald Elevator/Dissector



Size

PS 7105-19

19cm/7 ½"

PS 9206-23

23cm/9"

Watson Cheyne Dissector



Length

PS 7203-18

18cm/7"

PS 9203-23

23cm/9"

PS 9203-25

25.5cm/10"

Freers Elevator/Dissector

- 18.5cm/7¼" length



PS 7602-18

Swedish Dissector

- 18cm/7" length



STANDARD ✦ **DELUXE** ≡ *Premium*

COMPLETE RANGE OF SURGICAL INSTRUMENTS SINCE 1925

Kolbel Shoulder Retractor

- With 3 pairs of detachable blades
- 23cm/9" length

SM1062-23

Complete set with 3 pairs of blades and retractor frame

SM1062-00

Retractor frame only



SM1063-36
Small blade



SM1064-53
Medium blade



SH1065-68
Large blade