



Surgical Instrument Catalogue

CHATTERJEE SURGICAL

Vol-1



Surgical Instrument Catalogue

CHATTERJEE SURGICAL

Vol - 1



Photography & Designed By

cine  *magic*

Surgical Instrument Catalogue Vol - 1

CHATTERJEE SURGICAL

1st Publication 19th February 2007

Publisher Chatterjee Surgical

Copyright Chatterjee Surgical

Photography & Designed By

cine  *magic*

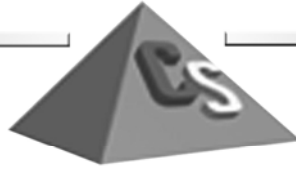

Preface

I have been requested to write the preface of this **Surgical Instrument Catalogue Vol-1** by my partners.

There are numerous books and catalogues available on Operating Instruments but from our experience we thought that a user friendly publication with illustration is necessary. Experience has shown us that buyers of surgical instruments get confused while going through catalogues available in the market. Having drawn experience from direct contacts with Surgeons, Physicians and Anesthetists as to their requirement individually as well as in seminars, it is our experience that they get confused from ordinary catalogues available in the market and they have requested us to produce a user friendly and illustrative instrument catalogue for them and this is the result thereof. Relevant information regarding specifications is given and we tried to keep ourselves upto date with international standards. This Catalogue provides profile of instruments on General Surgery, Intestinal, Proctology, Urology and Gynecology & Obstetrics. We have further intention to publish another catalogue which will include E.N.T, Neurosurgery, Cardiothoracic, Plastic Surgery, Anesthesia Equipment, Oxygen Therapy Instrument and other instruments with optical fibers and light sources.

I hope this catalogue will be of assistance to the medical profession as well as to dealers in this trade.



Monoranjan Chatterjee

MONORANJAN CHATTERJEE

INDEX

A

ITEM NAME	PAGE NO
Abdominal Retractor	18,19,20
Adson Dissecting Forcep	12
Allis Tissue Forceps	5
American Pattern Umbilical Scissor	42
Amniotomy Forcep Goodwin	40
Anal Retractor	26
Anderson Obstetric Forcep	41
Aneurysm Needle	8
Artery Forceps	1,2,3,4
Auvarad Vaginal Speculam	35

B

ITEM NAME	PAGE NO
Babcock Tissue Forcep	6
Backhaus Towel Clip	7
Back Bile Duct Dilators	25
Bandage Cutting Scissor	16
Bard Parker Handle	10
Barnes Episiotomy Scissor	42
Belfour Retractor Self Retaining	19
Biopsy Forcep	39
Bladder Retractor Millan	32
Bonney Dissecting Forcep	13
Bonney Myomectomy Clamp	34
Bonney Uterine Polypus Forcep	38
Bozeman Uterine Dressing Forcep	38
Bozeman Needle Holder	8
Brodie Director Probe Ended	9

C

ITEM NAME	PAGE NO
'C' Shape Retractor	17
Cannula	40
Capsule Forcep	32
Catheter Introducer	29
Catheter	29
Cheatle Sterilizing Forcep	11
Cheek Retractor	21
Cholecystectomy Forcep	24,25
Clamp	23,24,30,34
Clip Applying Forceps	8
Collingwood Steward Hernia Forcep	9
Crile Artery Forcep	2
Curette	37,39
Cusco Vaginal Speculam	36
Cutical Scissor	14
Czerny Retractor	18

INDEX

D

ITEM NAME	PAGE NO
D.N.C Set	43
Datigues Uterus Holding Forcep	34
Deaver's Retractor	18
Desjardine Gallstone Forcep	25
Dilators	25,28,37
Director	9
Dissector Thyroid	10
Dissecting Forcep	12,13,22
Doyen Intestinal Clamp	23
Doyen Mymo Screw	35
Doyen Polypus Forcep	38
Doyen's Retractor	20,35,36
Dressing Scissor	14
Duckbill Speculum	36

E

ITEM NAME	PAGE NO
Endometrial Biopsy Curette	39
Episiotomy Scissor	16,42

F

ITEM NAME	PAGE NO
Forceps -----	
Amniotomy	40
Artery	1,2,3,4
Biopsy	39
Capsule	32
Cholecystectomy	24,25
Clip Applying & Extracting	8
Dissecting	12,13,22,
Female Catheter	29
Fistula Director & Probe	9
Flushing Curette	37
Foreign Body Remover	9
Gallstone	25
Hernia	9
Hysterectomy	33,34
Kidney Stone	30,31
Obstetric	41
Ovum	41,42
Piles	27
Sponge Holding	11
Sterilizing	11
Tissue	5,6
Uterus Dressing	38
Uterus Holding	34
Uterus Volsellum	38

INDEX

G

ITEM NAME	PAGE NO
Galabin Uterine Sound	39
Gallstone Forcep	25
Gillies Dissecting Forcep	12
Gilles Needle Holder & Suture Cutter	8
Gillies Skin Retractor	17
Goodwin Amniotomy Forcep	40
Greenarmytage Clamp	41
Gwilliam Hysterectomy Forcep	33

H

ITEM NAME	PAGE NO
Haemostatic Clamp Greenarmytage	41
Halsey Needle Holder	7
Halsted Mosquito Artery Forcep	1
Hegar Cervix Dilator	37
Hendricks Kidney Pedical Clamp	30
Hernia Forcep	9
Hook Retractor	16,17
Hysterectomy Forcep	33,34

I

ITEM NAME	PAGE NO
Intestinal Clamp	23,24
I.U.D Removing Hook	40
Intra Uterine Cannula	40

J

ITEM NAME	PAGE NO
Jansen Retractor	21

K

ITEM NAME	PAGE NO
Kelly Artery Forcep	2
Kidney Pedicle Clamp	30
Kochers Artery Forcep	3
Kocher Thyroid Dissector	10
Krischner Retractor	19

L

ITEM NAME	PAGE NO
Lahey Artery Forcep	4
Lahey Cholecystectomy Forcep	24
Landon Vaginal Retractor Blade	35
Lane Tissue Forcep	6
Langenbeck Retractor	18
Leech Wilkinson Intra Uterine Cannula with silette	40
Lister Scissor Bandage Cutting	16
Little wood Tissue Forcep	6
Lloyd Davis Sigmoid scope	28

INDEX

M

ITEM NAME	PAGE NO
Maingot Hysterectomy Forcep	33
Mayo Clinic Pedicle Clamp	30
Mayo Diamond Jaw Scissor	22
Mayo Hegar Needle Holder	7
Mayo Robson Doyen Intestinal Clamp	23
Mayo Scissor	15
McClintock Ovum Forcep	42
Mc Indoe Dissecting Forcep	12
Metzenbuam Diamond Jaw Scissor	22
Metzenbuam Scissor	14
Michel Clip Applying Forcep	8
Millan Bladder Retractor	32
Millan Prostatic Capsule Forcep	32
Millan Sound Galabin Uterine	39
Mixture Artery Forcep	4
Modified Pile Gun	28
Morris Retractor	18
Mosquito Artery Forcep	1
Moynihan Artery Forcep	3
Moynihan Cholecystectomy Forcep	25
M.T.P Cannula	40
Mymectomy Boney Clamp	34
Mymo Doyen Screw	35

N

ITEM NAME	PAGE NO
Needle Eve Aneurysm	8
Needle Holder Bozeman	8
Needle Holder Diamond	22
Needle Holder Gilles & Suture	8
Needle Holder Hager	7
Needle Holder Halsey	7
Nested Trocars	10
Novak Suction Curette Luer	39

O

ITEM NAME	PAGE NO
Obstetric Forcep	41
Ovum Forcep	41,42

INDEX

P

ITEM NAME	PAGE NO
Park Anal Retractor	26
Parker Bard Handle	10
Payr Intestinal Clamp	24
Pean Rochester Artery Forcep	3
Pedicle Clamp	30
Piles Gun	27,28
Plaster Cutting Saw	21
Poly Forcep	38
Pool Suction Tube	24
Pouch For D.N.C Set	43
Pozzi Abdominal Retractor	20
Probes	9
Proctoscope	26
Prostatic Millan Capsule Forcep	32

R

ITEM NAME	PAGE NO
Ramsey Dissecting Forcep	13
Rectal Dilator	28
Renal Stone Turner Warwick	31
Rental Renal Calculus Forcep	30
Retractor	16,17,18,19,20,21,31,32,35
Retractor Blade Doyen Vaginal	36
Retractor Blade Landon Vaginal	35
Right Angled Artery Forcep	4
Rochester Pean Artery Forcep	3
Russian Dissecting Forcep	13

S

ITEM NAME	PAGE NO
Schroeder Uterine Volsellum Forcep	38
Scissors	14,15,16,22,42
Sherman Endometrial Biopsy	39
Sigmoidoscope Lloyd Davis	28
Sinus	4,9
Somers Uterus Holding Forcep	34
Speculams	35,36
Spencer Wells Artery Forcep	2
Sponge Holding Forcep	11
Sterilizing Forcep Cheatle	11
Suction Tube	24

INDEX

T

ITEM NAME	PAGE NO
Thomson Walker Retractor	31
Thyroid Dissector Kocher	10
Tischler Biopsy	39
Tissue Forcep	5,6
Towel Clip	7
Travers Retractor	21
Trocars Nested	10
Turner Warwick Renal Stone	31

U

ITEM NAME	PAGE NO
Umbilican American Pattern	42
Uterine Curettes	37
Uterine Flushing Curettes	37
Uterine Forcep	38
Uterine Galabin Sound Malleable Shaft Graduated	39,40
Uterus Holding Forcep	34

V

ITEM NAME	PAGE NO
Vaginal	35,36
Volkmann Retractor	17
Volsellum	38

W

ITEM NAME	PAGE NO
Walker Thomson Retractor	31
Warwick Turner Renal Stone	31
Wagh Dissecting Forcep	13
Wells Artery Forcep	2
Wire Cutter Scissor	15
Wrigly Obstetric Forcep	41

Y

ITEM NAME	PAGE NO
Yankaur Suction Tube	24

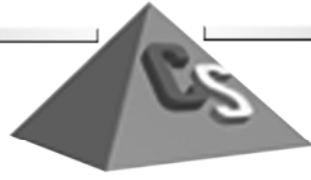

GENERAL SURGERY

GENERAL SURGERY

GENERAL SURGERY





CS-A-001

CS-A-001 : Mosquito Artery Forcep
4" 100mm. Straight.



CS-A-002

CS-A-002 : Mosquito Artery Forcep
4" 100mm. Curved



CS-A-004

CS-A-003 : Mosquito Artery Forcep
5" 125mm. Straight.

CS-A-004 : Mosquito Artery Forcep
5" 125mm. Curved.



CS-A-006

CS-A-005 : Halstead Mosquito Artery Forcep
5" 125mm. Straight.

CS-A-006 : Halstead Mosquito Artery Forcep
5" 125mm. Curved.

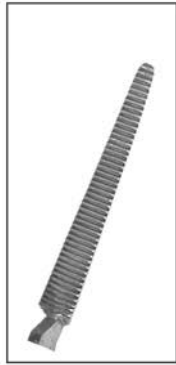
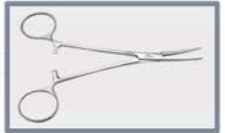

CS-A-010

- CS-A-009: Spencer Wells Artery Forcep**
5" 125mm Straight/Curved.
- CS-A-010: Spencer Wells Artery Forcep**
6" 150mm Straight/Curved.
- CS-A-011: Spencer Wells Artery Forcep**
7" 175mm Straight/Curved.



CS-A-012

- CS-A-012: Spencer Wells Artery Forcep**
8" 200mm Straight/Curved.
- CS-A-013: Spencer Wells Artery Forcep**
9" 225mm Straight/Curved.
- CS-A-014: Spencer Wells Artery Forcep**
10" 250mm Straight/Curved.



CS-A-015

- CS-A-015: Kelly Artery Forcep**
5.5" 140mm Straight/Curved.



CS-A-017

- CS-A-016: Crile Artery Forcep**
5.5" 140mm Straight/Curved.
- CS-A-017: Crile Artery Forcep**
6.5" 165mm Straight/Curved.

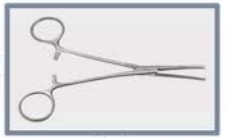

CS-A-018

CS-A-018: Moynihan Artery Forcep
5.75" 145mm Straight/Curved
Half Serrated Jaws



CS-A-020

CS-A-019: Rochester-Pean Artery Forcep
6.5" 165mm Straight/Curved.
CS-A-020: Rochester-Pean Artery Forcep
8" 200mm Straight/Curved.



CS-A-022

CS-A-022: Kochers Artery Forcep
6" 150mm Straight/Curved.



CS-A-024

CS-A-023: Kochers Artery Forcep
7" 175mm Straight/Curved.
CS-A-024: Kochers Artery Forcep
8" 200mm Straight/Curved.

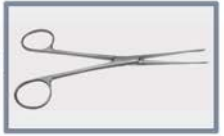

CS-A-026

- CS-A-025: Right Angle Artery Forcep 6"150mm Straight/Curved.**
- CS-A-026: Right Angle Artery Forcep 8"200mm Straight/Curved.**
- CS-A-027: Right Angle Artery Forcep 10"250mm Straight/Curved.**



CS-A-029

- CS-A-028: Lahey Artery Forcep Longitudinal Serration 8", 9"200mm 230mm Curved on flat.**
- CS-A-029: Lahey Artery Forcep Longitudinal Serration 8", 9"200mm 230mm Curved on flat.**



CS-A-030

- CS-A-030: Mixture Artery Forcep 9"230mm Curved on flat.**



CS-A-031

- CS-A-031: Sinus Forcep 6"150mm.**
- CS-A-032: Sinus Forcep 7"180mm.**



CS-A-034

CS-A-034:Allis Tissue Forcep 4"100mm. 3x4 teeth.



CS-A-035

CS-A-035:Allis Tissue Forcep 6"150mm. 4x5 teeth.



CS-A-036

CS-A-036:Allis Tissue Forcep 8"200mm. 5x6 teeth.

CS-A-041:Stile Tissue Forcep 8"200mm. 6x7 teeth.



CS-A-038

CS-A-037:Allis Tissue Forcep 6"150mm. with Autraumatic Grip.

CS-A-038:Allis Tissue Forcep 8"200mm. with Autraumatic Grip.

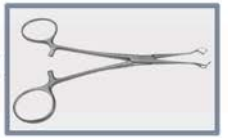

CS-A-040

**CS-A-040: Little Wood Tissue Forcep 7.5"190mm.
2x3 teeth.**



CS-A-042

**CS-A-042: Lane Tissue Forcecp 6", 7"150mm,
175mm. 1x2teeth.**



CS-A-044

**CS-A-043: Babcock Tissue Forcecp 4"100mm,
Serration/Slit Jaws**

**CS-A-044: Babcock Tissue Forcecp 6"150mm,
Serration/Slit Jaws**

**CS-A-045: Babcock Tissue Forcecp 8"200mm,
Serration/Slit Jaws**



CS-A-047

**CS-A-046 : Babcock Tissue Forcecp 6"150mm,
with Autraumatic Grip.**

**CS-A-047: Babcock Tissue Forcecp 8"200mm,
with Autraumatic Grip.**



CS-A-048

CS-A-048:Towel Clip Cross Action.



CS-A-050

CS-A-049:Backhaus Towel Clip 4" 100mm.

CS-A-050:Backhaus Towel Clip 5" 125mm.

CS-A-051:Backhaus Towel Clip 6" 150mm.



CS-A-055

CS-A-054:Halsey Needle Holder 4",5"100mm.125mm.

CS-A-055:Mayo Hegar Needle holder 6"150mm
Straight/ Curved.



CS-A-056

CS-A-056: Mayo Hegar Needle holder
7",8"180mm 200mm Straight/ Curved.

CS-A-057: Mayo Hegar Needle holder
9",10"230mm 255mm
Straight/ Curved.



CS-A-062

CS-A-062: Bozeman Needle Holder 6"150mm Double Curved.

CS-A-063: Bozeman Needle Holder 7"180mm 8" 200mm Double Curved.



CS-A-065

CS-A-065: Gilles Needle Holder & Suture Cutter 6"150mm.



CS-A-068

CS-A-067: Aneurysm Needle Eve 7.5"190mm.

CS-A-068: Aneurysm Syme 6.5" 165mm.

CS-A-069: Aneurysm Decamps 8"200mm Right &Left.



CS-A-072

CS-A-071: Michel Clip Applying Forcep 5"125mm 4x4 teeth.

CS-A-072: Michel Clip Applying & Extracting Forcep 5" 125mm.

CS-A-073: Michel Clip Extracting Forcep 4.75" 120mm.



CS-A-075

CS-A-075: Sinus Probe 6" 150mm

CS-A-076: Probes 5" 6" 7" 8" 125mm
150mm 175mm 200mm.



CS-A-077

CS-A-078

CS-A-077: Fistula Director 5" 125mm.

CS-A-078: Brodie Director Probe ended
6.5" 165mm.

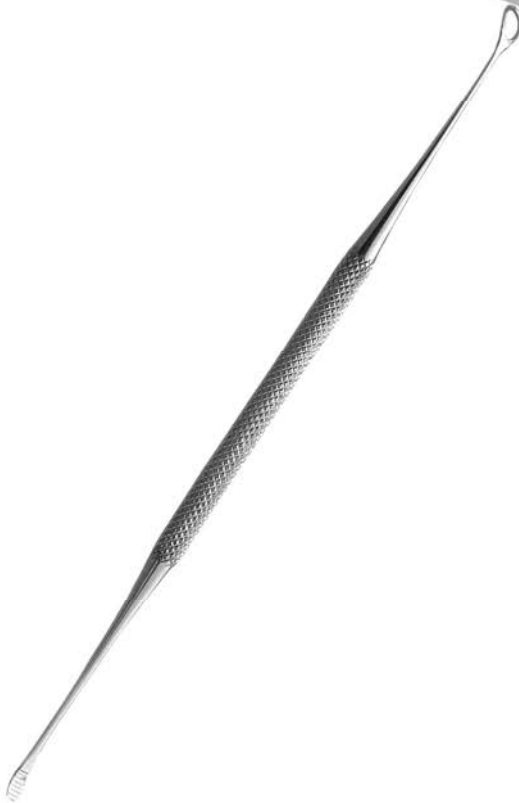

CS-A-080

CS-A-080: Foreign Body Remover 5" 6" 8"
125mm 150mm 200mm



CS-A-084

CS-A-084: Collingwood Steward Screw Joint
Hernia Forcep Ring Bladed
5.5" X 5.5"



CS-A-085

CS-A-085 : Kocher Thyroid Dissector
6.25" 160mm 6.5" 165mm 7" 175mm



CS-A-087

CS-A-087 : Nested Trocars 2,5,8, Eng gauge
Cannula Set of 3 in Metal case
6.5" 165mm

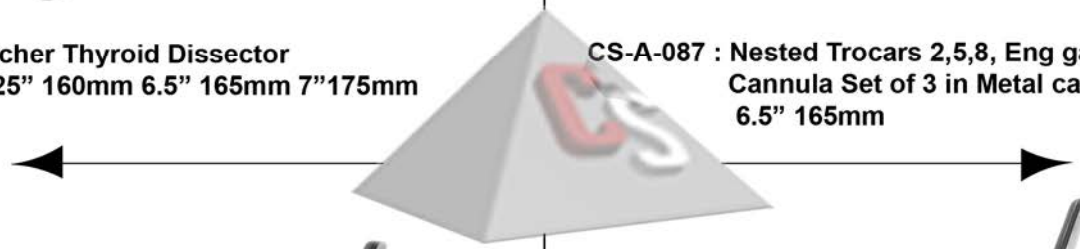

CS-A-091

CS-A-091 : Bard Parker Handle no 3 /4

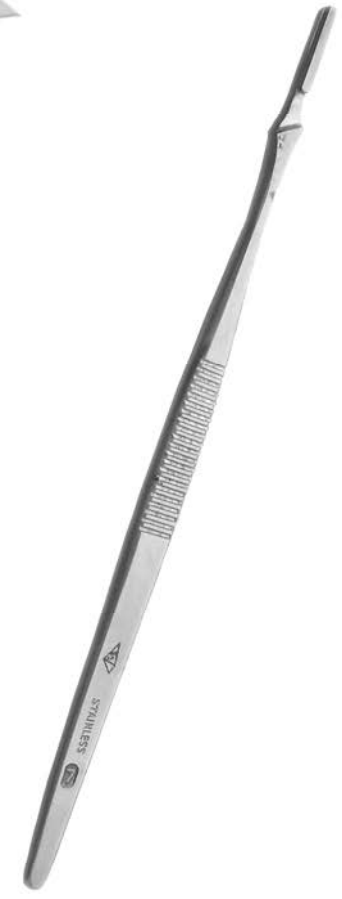

CS-A-092

CS-A-092 : Bard Parker Handle no 7

CS-A-093 : Bard Parker Handle Combined no 3 & 4

CS-A-094 : Bard Parker Handle Excel no 3 , 4



CS-A-097

**CS-A-097 :Sponge Holding Forcep
6" 8" 150mm,200mm.**



CS-A-098

**CS-A-098 :Sponge Holding Forcep
10" 250mm.**

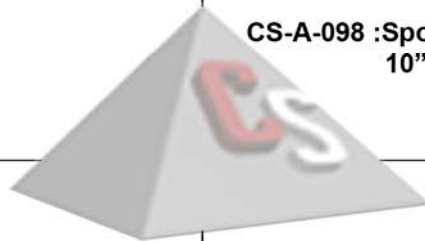

CS-A-100

**CS-A-099 :Sterilizing forcep Cheatle
6"8" 150mm,200mm.SJ/BJ**

**CS-A-100: Sterilizing forcep Cheatle
10" 250mm Narrow Jaws.**



CS-A-101

**CS-A-101: Sterilizing forcep Cheatle
10" 250mm Broad Jaws.**

**CS-A-102: Sterilizing forcep Cheatle
11.5" 290mm Broad Jaws.**

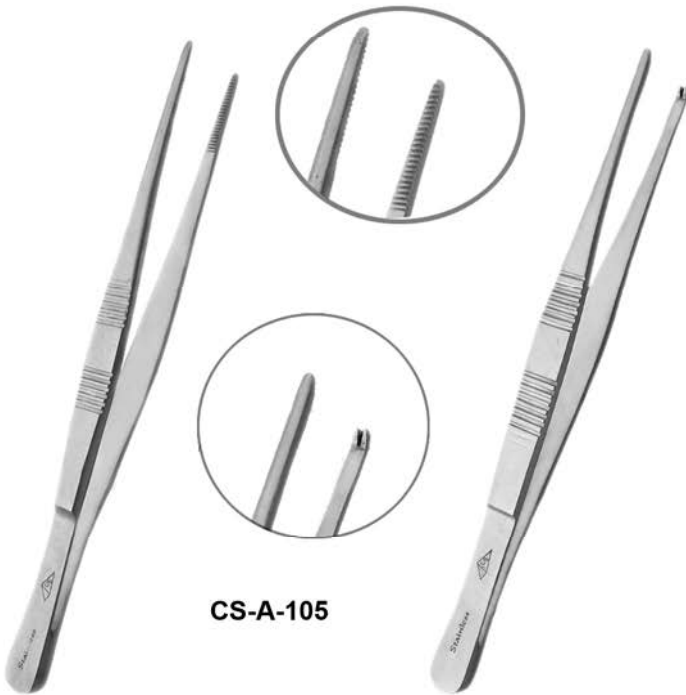
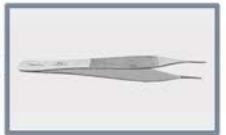

CS-A-105

**CS-A-105 :Dissecting Forcep Plain / Toothed
4"5"6" 100mm 125mm 150mm.**



CS-A-106

**CS-A-106 :Dissecting Forcep Plain / Toothed
7"8"180mm 200mm**

**CS-A-107:Dissecting Forcep Plain / Toothed
9"10" 230mm 250mm**

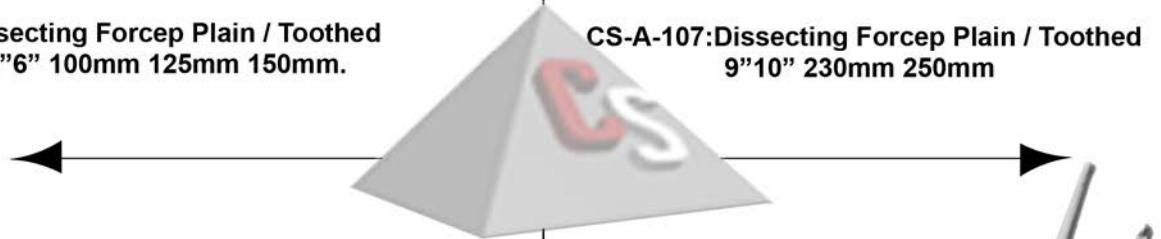

CS-A-108



**CS-A-108:Adson Dissecting Forcep Plain / Toothed
4"5"Fine 100mm 125mm.**

**CS-A-109:Adson Dissecting Forcep Plain / Toothed
6"7"Fine 150mm 180mm.**

CS-A-110



**CS-A-110:Mc Indose Dissecting Forcep
6" 150mm**

**CS-A-111:Gillies Dissecting Forcep
6" 150mm.**



CS-A-112

**CS-A-112 :Russian Dissecting Forcep
6" 7" 150mm 180mm.**



CS-A-113

**CS-A-113 :Waugh Dissecting Forcep
Plain/Toothed 6" 8" 150mm 200mm.**

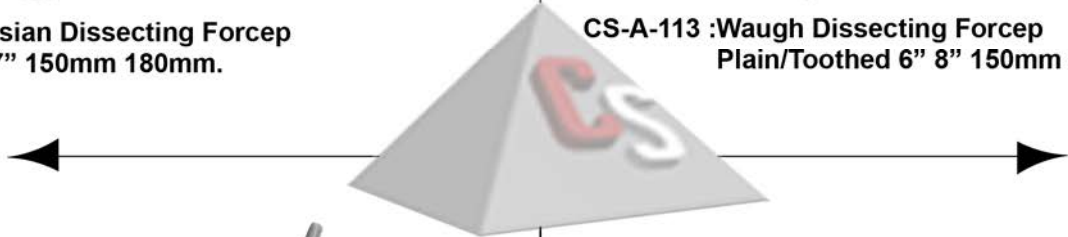

CS-A-115

**CS-A-115:Ramsey Dissecting Forcep Plain / Toothed
7" 180mm.**

**CS-A-116:Bonney Dissecting Forcep Plain / Toothed
7" 180mm.**



CS-A-117

**CS-A-117:Debakey Dissecting Forcep 6" 7"
150mm 180mm Autraumatic Grip**

**CS-A-118:Debakey Dissecting Forcep 8"
200mm Autraumatic Grip**



CS-A-120

**CS-A-120 :Cutical Scissor Fine Straight / Curved 4"5"
100mm 125mm.**



CS-A-121

**CS-A-121 :Dressing Scissor S/S,S/B,B/B
Straight / Curved 5"6" 125mm 150mm.**
**CS-A-122 :Dressing Scissor S/S,S/B,B/B
Straight / Curved 7"8" 180mm 200mm.**
**CS-A-123 :Dressing Scissor S/S,S/B,B/B
Straight / Curved 9"10" 230mm 250mm.**



CS-A-125

**CS-A-124 : Scissor Metzenbaum
Straight / Curved 4"5" 100mm 125mm.**
**CS-A-125 : Scissor Metzenbaum
Straight / Curved 6"7" 150mm 180mm.**



CS-A-126

**CS-A-126: Scissor Metzenbaum Straight / Curved
7.5"8" 190mm 200mm.**
**CS-A-127: Scissor Metzenbaum Straight / Curved
9"10" 230mm 250mm.**
**CS-A-128: Scissor Metzenbaum Nelson
Straight / Curved 10"11"12"
250mm 280mm 300mm.**

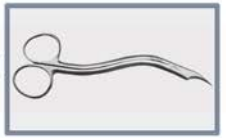

CS-A-132



CS-A-133

CS-A-130 : Scissor Mayo's Round / Flat Blade Straight / Curved 4"4.5" 100mm 110mm.

CS-A-131 : Scissor Mayo's Round / Flat Blade Straight / Curved 5"5.5" 125mm 140mm.

CS-A-132 : Scissor Mayo's Round / Flat Blade Straight / Curved 6"6.5" 150mm 165mm.

CS-A-133 : Scissor Mayo's Round / Flat Blade Straight / Curved 7.5"8" 190mm 200mm.

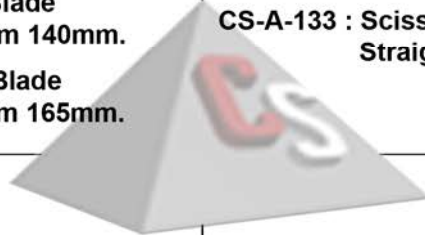

CS-A-134



CS-A-135



CS-A-136

CS-A-134 : Scissor Suture Removing Heath 6" 150mm.

CS-A-135 : Scissor Suture Removing Littaeur 5.5" 140mm.

CS-A-136 : Scissor Wire Cutter Universal 5" 125mm.



CS-A-138



CS-A-137 : Scissor Bandage Cutting
5.5" 140mm (LISTER).

CS-A-138 : Scissor Bandage Cutting
7" 180mm (LISTER).

CS-A-139 : Scissor Bandage Cutting
9" 230mm (SEUTIN).

CS-A-140



CS-A-140 : Scissor Episiotomy Barnes
5"6" 125mm 150mm.

CS-A-141



CS-A-141 : Scissor Episiotomy Barnes
5"7" 125mm 180mm.

CS-A-143



CS-A-143 : Retractor Hook Single Sharp / Blunt
6" 150mm. .



CS-A-144

CS-A-145

CS-A-144 : Retractor Hook Double Sharp / Blunt
7" 180mm.

CS-A-145 : Retractor Gillies Skin
7" 180mm.



CS-A-148

CS-A-148: Retractor Roux Set of 3
C Shape .

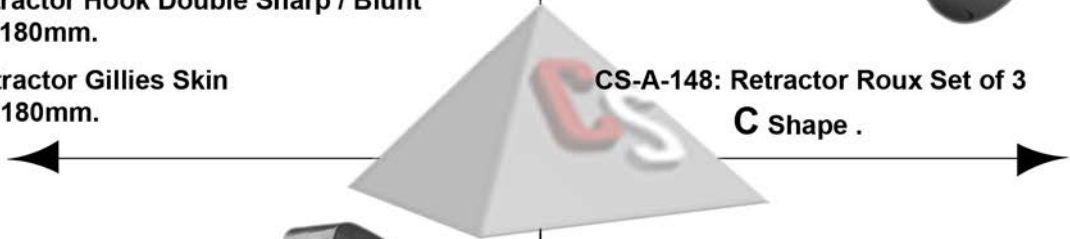

CS-A-149

CS-A-149: Retractor Lane Double Ended
9" 230mm.(0.5" x 0.75" in wide)



CS-A-151

CS-A-150 : Retractor Volkmann 1,2 Prongs
8.5" 215mm Sharp / Blunt.

CS-A-151 : Retractor Volkmann 3,4,6 Prongs
8.5" 215mm Sharp / Blunt.

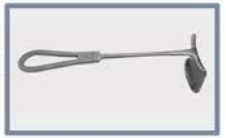

CS-A-153



CS-A-153 : Retractor Langenbeck 0.25", 0.5", 0.75"
wide 8.25" 210mm.

CS-A-154



CS-A-154 : Retractor Morris 1.5", 2", 2.5"
wide Blade 9" 230mm.

CS-A-155



CS-A-155 : Retractor Czerny Double Ended 6"
8", 150mm 200mm.

CS-A-156



CS-A-156: Retractor Deavers Abdominal
0.75", 1" x 12"

CS-A-157: Retractor Deavers Abdominal
1.5", 2" x 12"

CS-A-158: Retractor Deavers Abdominal
2.5", 3" x 12"

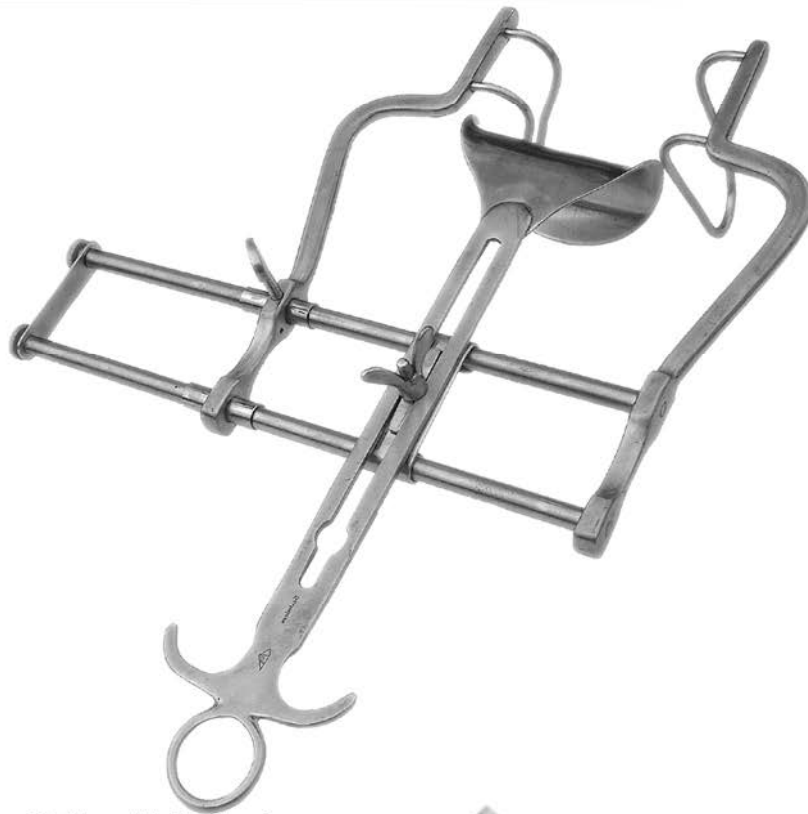
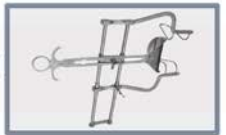

CS-A-163

**CS-A-163 : Retractor Belfour Abdominal
Self Retaining**

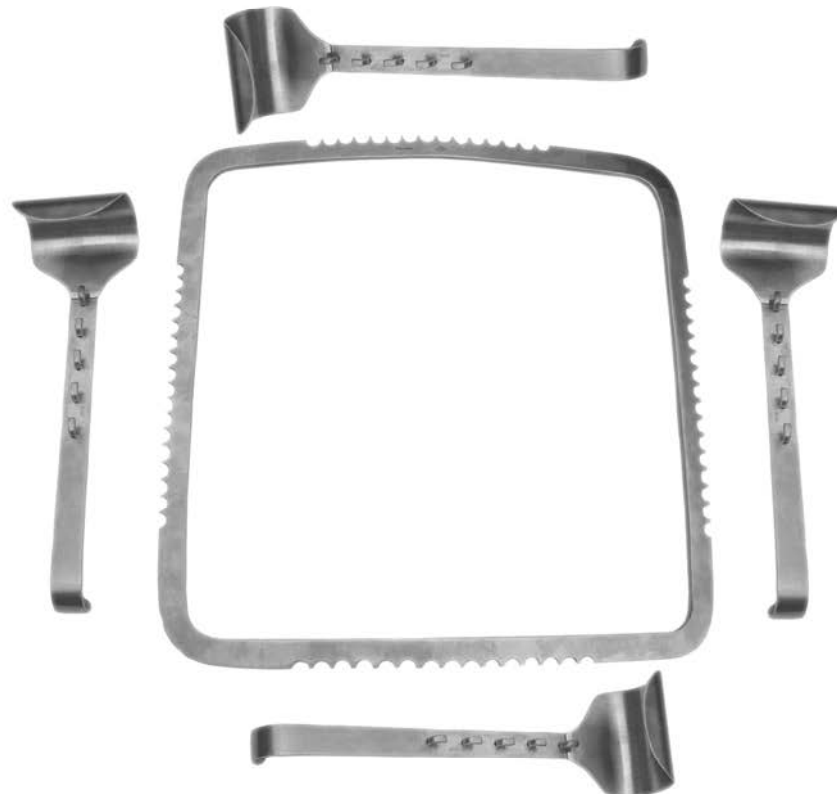

CS-A-166

CS-A-166 : Retractor Kirschner Set Self Retaining



CS-A-164

**CS-A-164 : Retractor Pozzi Abdominal
Self Retaining**



CS-A-160

**CS-A-160 : Retractor Doyen's Abdominal Blade
2", 2.5", 3"**

**CS-A-161 : Retractor Doyen's Abdominal Blade
3.5", 4"**



CS-A-168

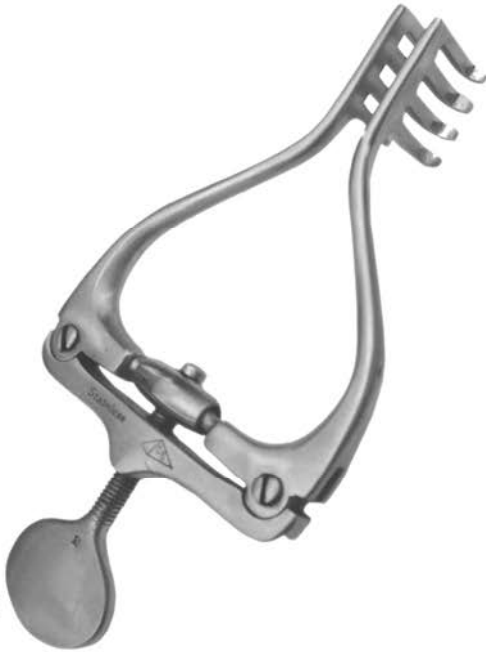

CS-A-168 : Retractor Jansen Self Retaining Small / Large

CS-A-169



CS-A-169 : Retractor Travers Self Retaining 4x5 Prongs 8.25" 210mm.

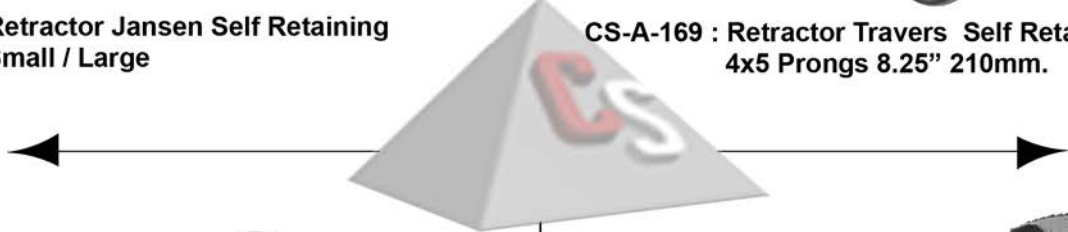

CS-A-173



CS-A-173 : Retractor Cheek

CS-A-174



CS-A-174 : Plaster Cutting Saw 6", 7" 150mm 180mm Engel

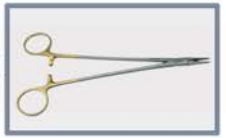

CS-A-066

CS-A-066 : Needle Holder Diamond TC Jaws
Straight / curved 6"7"8" 150mm 180mm
200mm.



CS-A-119 : Dissecting Forceps with Diamond
Tips All Sizes Plane / Cross serration.

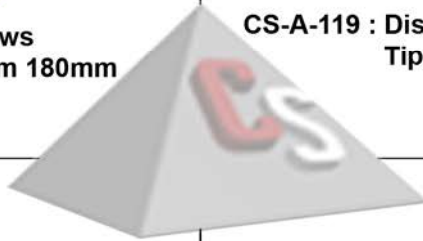

CS-A-129

CS-A-129 : Scissor Metzenbaum Diamond Jaws
Straight / curved 6"7"8" 150mm 180mm
200mm.



CS-A-142

CS-A-142 : Scissor Mayo's Diamond Jaws
Straight / curved all Sizes.

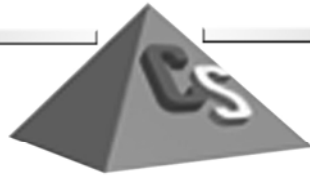

Intestinal

Intestinal



Intestinal



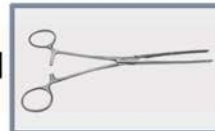

CS-B-006



CS-B-006 : Doyen (Mayo Robson) Intestinal Clamp
Straight / Curved
8" 200mm.

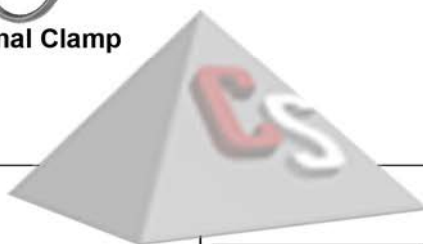

CS-B-007



CS-B-008



CS-B-007 : Doyen (Mayo Robson) Intestinal Clamp
Straight / Curved 9"10" 230mm 250mm.

CS-B-008 : Doyen intestinal Clamp
Straight / Curved 2x3 Atraumatic
Grip 8"9"10" 200mm 230mm
250mm.



CS-B-013

CS-B-013 : Payr Intestinal Clamp
8.25"9.5" 210mm 240mm.



CS-B-014

CS-B-014 : Pool Suction Tube 9.5" 240mm.

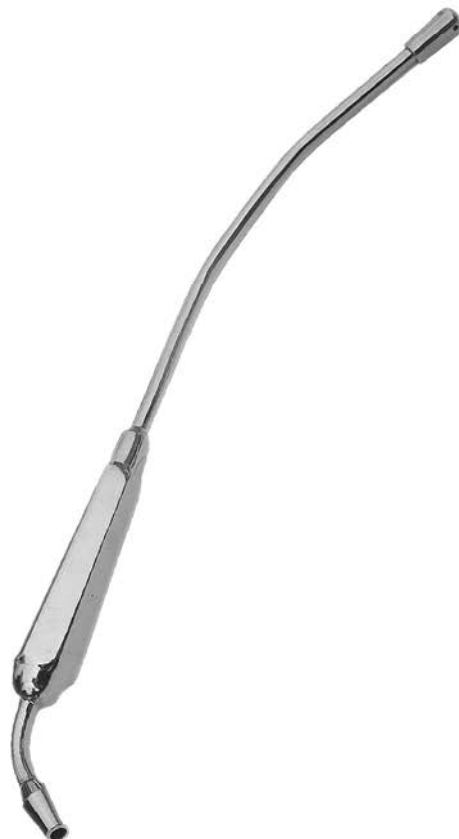
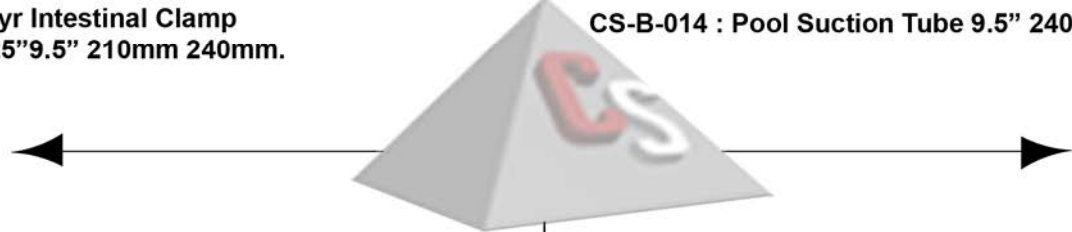

CS-B-015

CS-B-015: Yankaur Suction Tube 12" 300mm.



CS-B-018

CS-B-018 : Lahey Cholecystectomy Forcep
7.75" 197mm Longitudinal
Serration.





CS-B-019

CS-B-019 : Moynihan Cholecystectomy Forcep
Curved on Flat 8.75" 222mm.

CS-B-020 : Moynihan Cholecystectomy Forcep
Screw Joint 11.5" 290mm.



CS-B-022 : Desjardins Gallstone Forcep
9.75" 245mm.

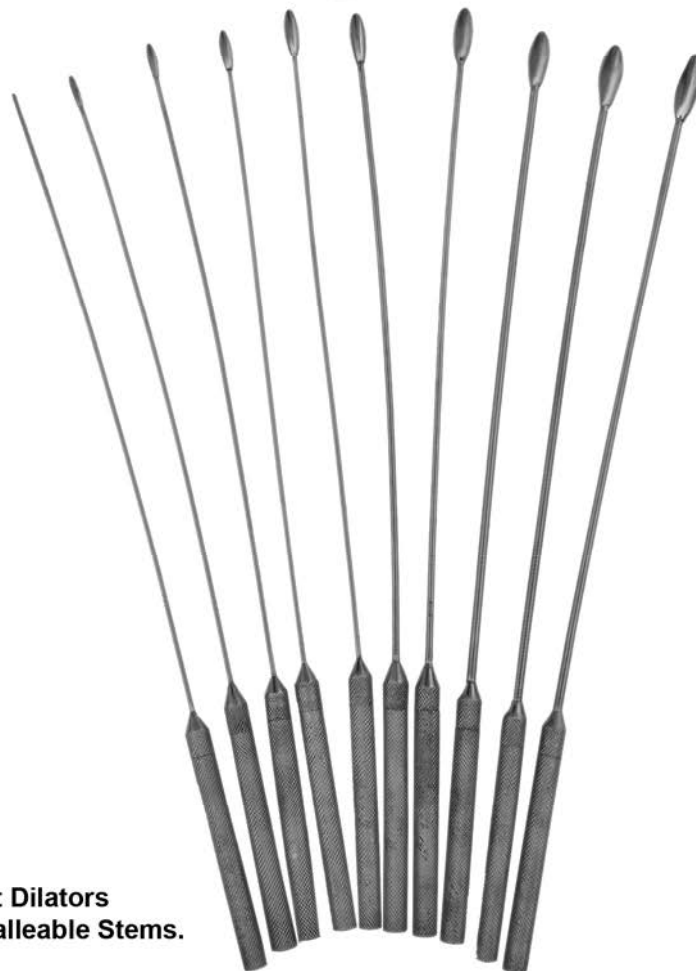
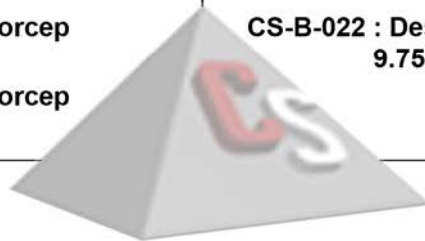

CS-B-023

CS-B-023 : Back Bile Duet Dilators
Set of 10 / 9 Malleable Stems.

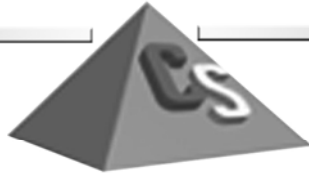

Proctology

Proctology



Proctology





CS-C-001

CS-C-001 : Proctoscope Large / Medium / Small
Chromium Plated Kelly.
CS-C-002 : Proctoscope Large / Medium / Small
Chromium Plated Gabriel.



CS-C-003 : Proctoscope with Light Source
Attachment

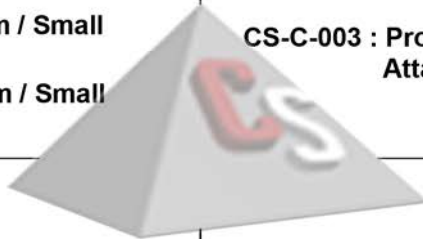

CS-C-004

CS-C-004 : Park Anal Retractor Adult.



CS-C-004

CS-C-004 : Park Anal Retractor Child.

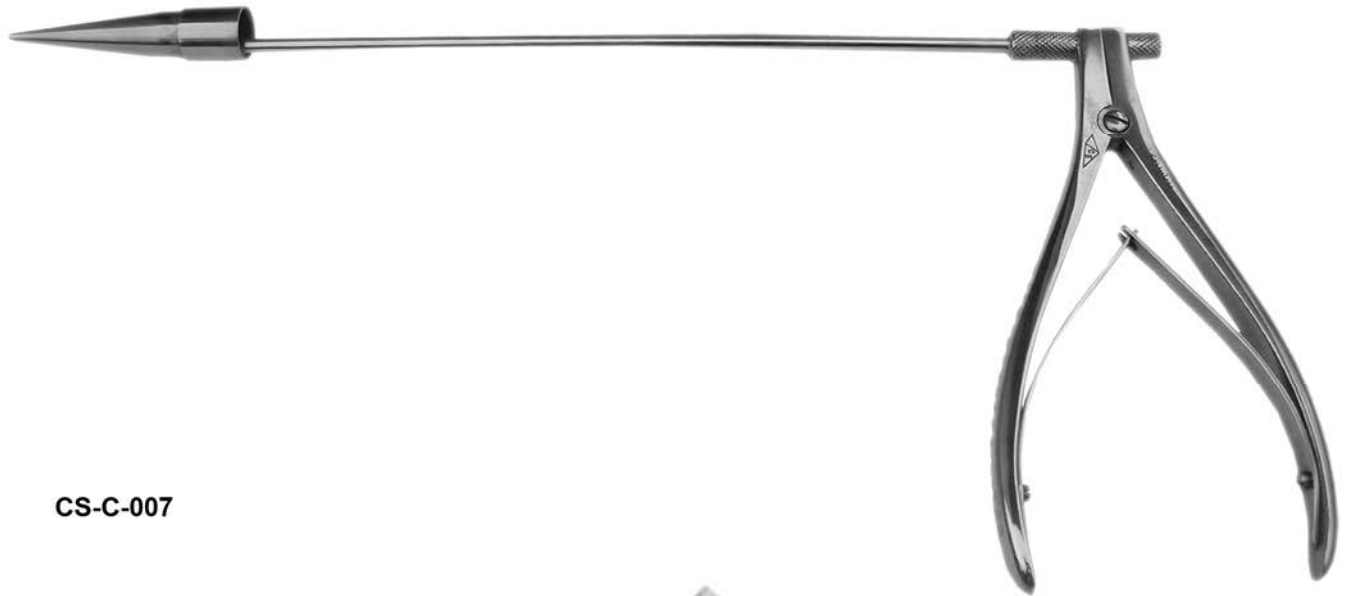
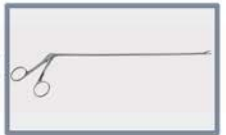

CS-C-007

CS-C-007 : Piles Gun 10.5" 270mm

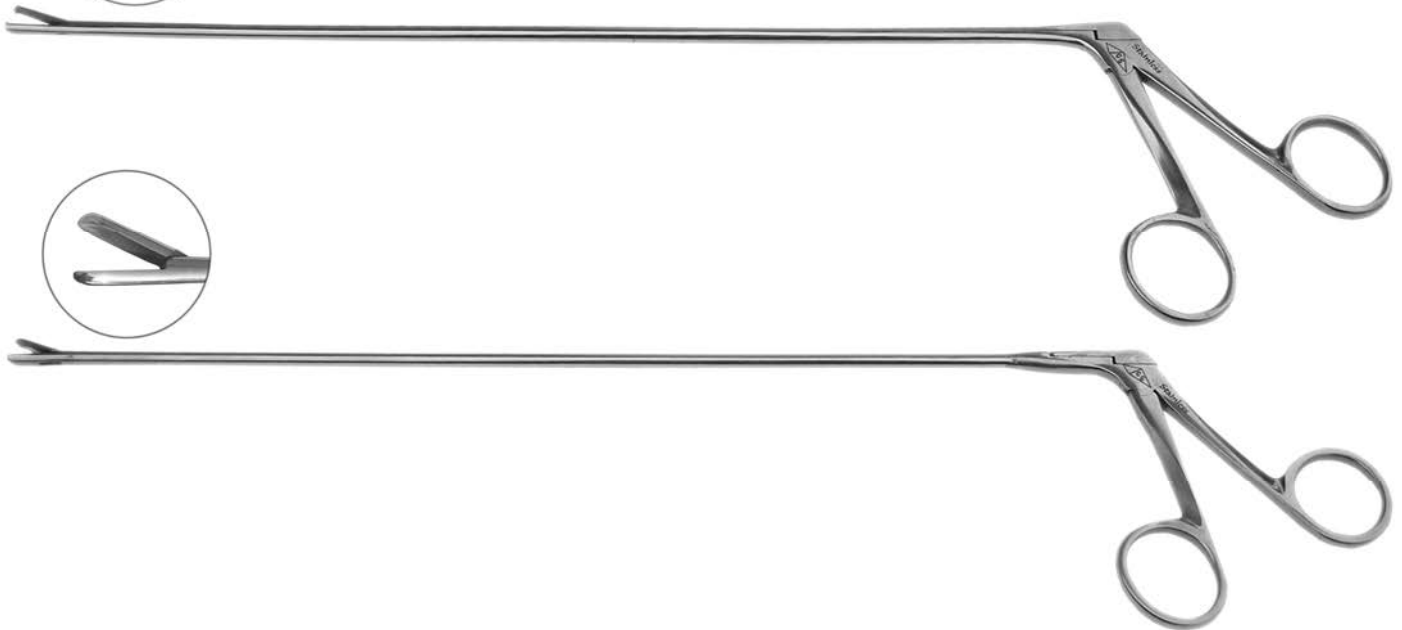

CS-C-008

CS-C-008 : Piles Forcep Serrated / Cup Jaws



CS-C-009

CS-C-009 : Modified Piles Gun

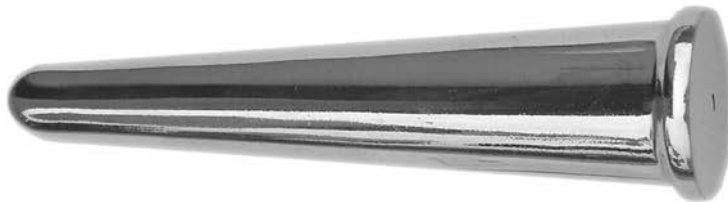

CS-C-011

CS-C-011 : Rectal Dilator Small / Large.

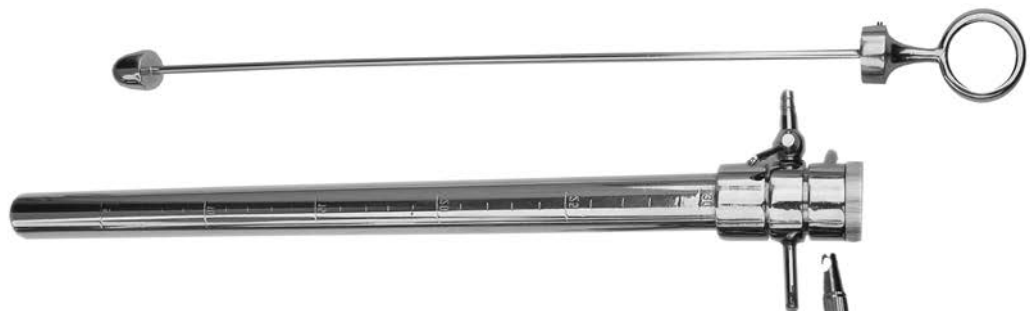

CS-C-012

CS-C-012 : Lloyd Davis Sigmoidoscope



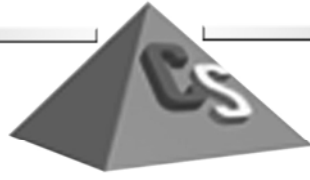

Urology

Urology

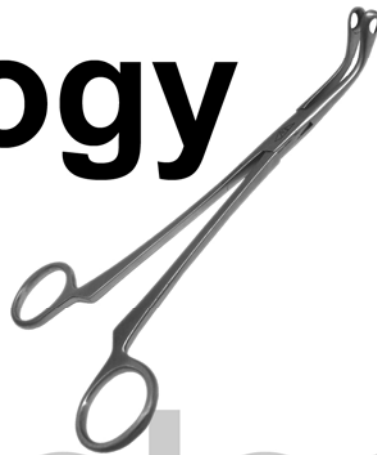

Urology





CS-D-001

CS-D-001 : Catheter Female Metal Standard Type

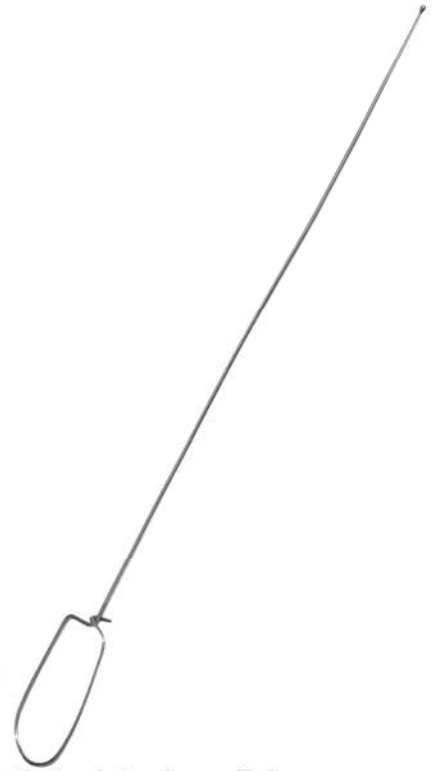

CS-D-003

CS-D-003 : Catheter Introducer Foleys

CS-D-004 : Catheter Introducer Guyon

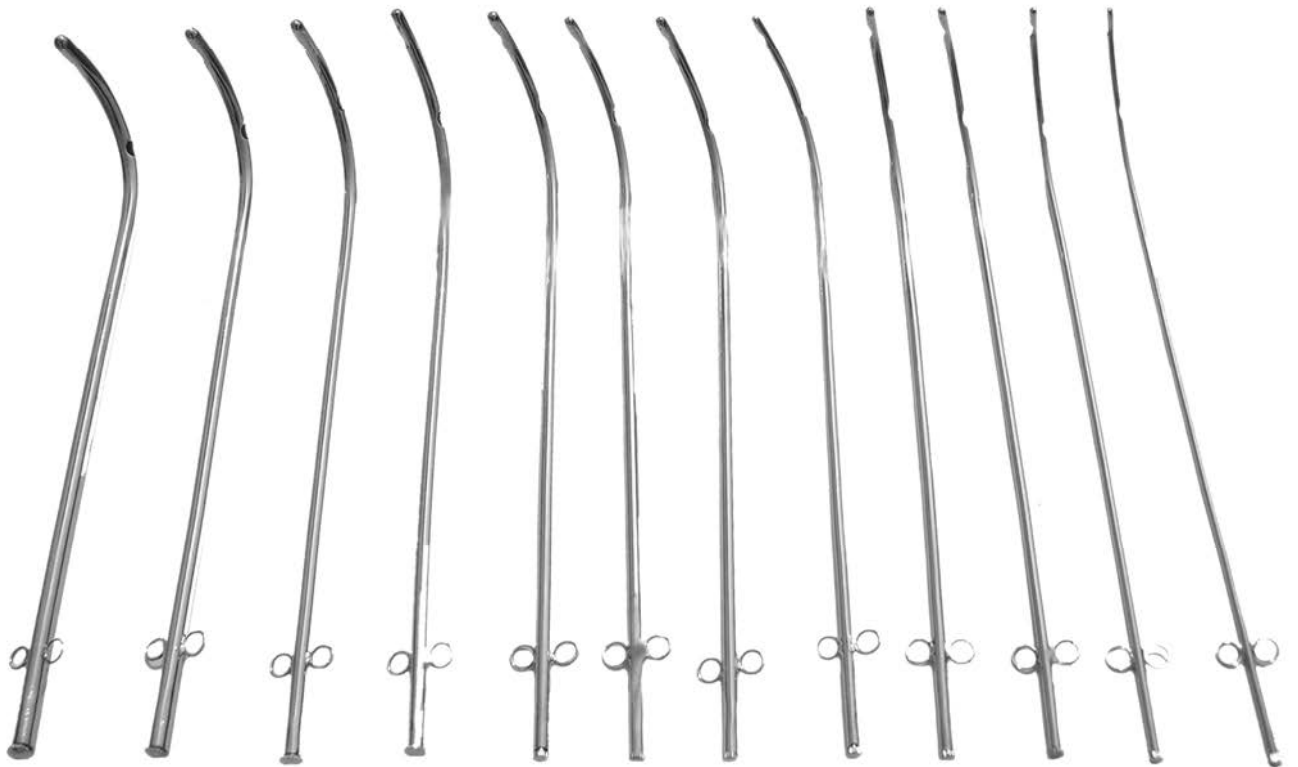

CS-D-002

CS-D-002 : Catheter Male Metal Set of 12



CS-D-005

CS-D-005 : Hendricks Kidney Pedicle Clamp
Autraumatic 1x2 Serration 10.5"
267mm.

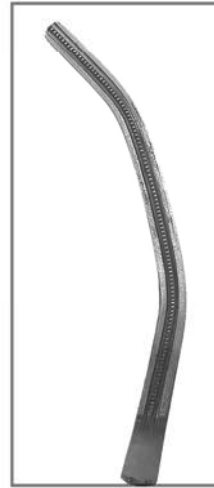

CS-D-006

CS-D-006 : Mayo Clinic Pedicle Clamp Screw
Joint 9.5" 240mm.

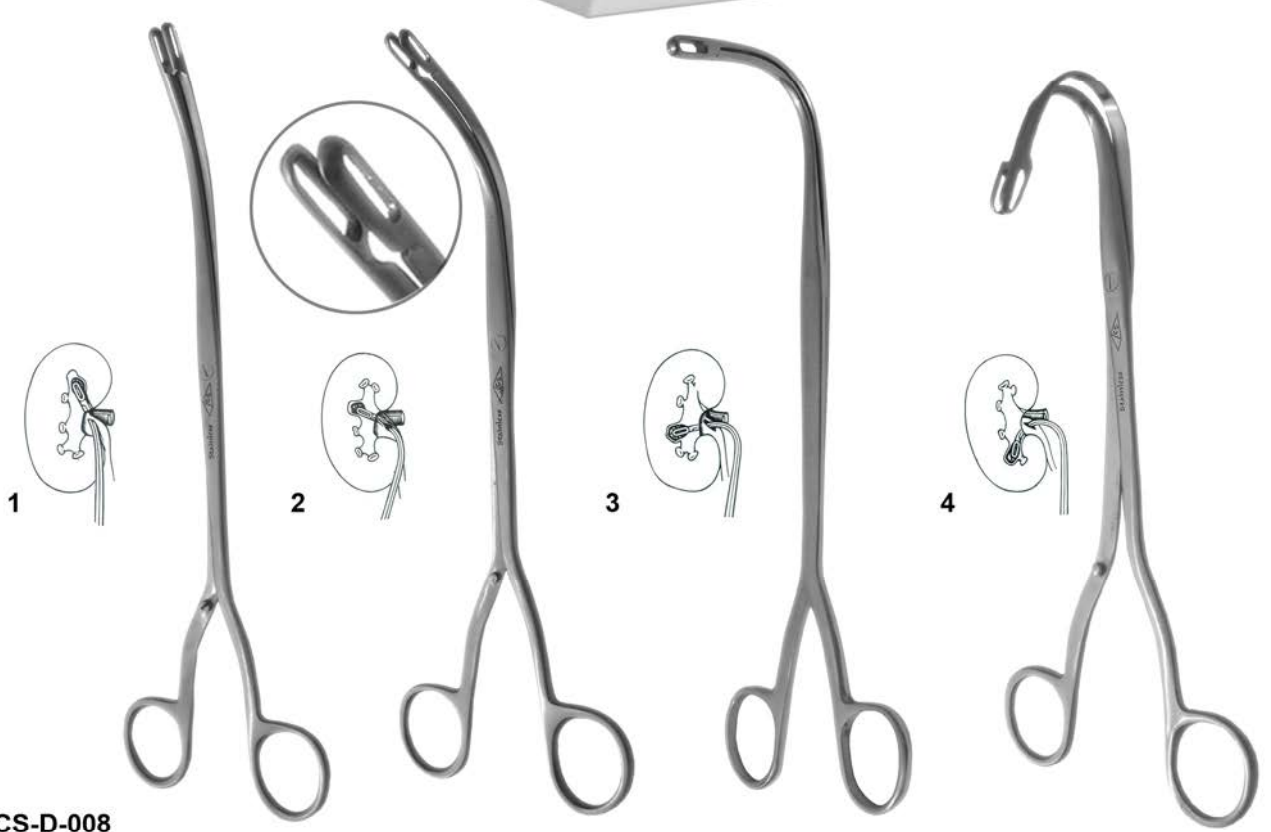
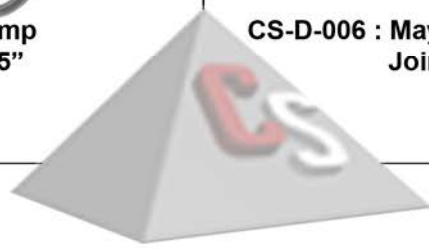

CS-D-008

CS-D-008 : Randal Renal Calculus Forcep Screw
Joint Set of 4 with Guard Pin.



CS-D-009

CS-D-009:Turner Warwick Renal Stone
Forcep Shallow /deep Curved 7.5"190mm.

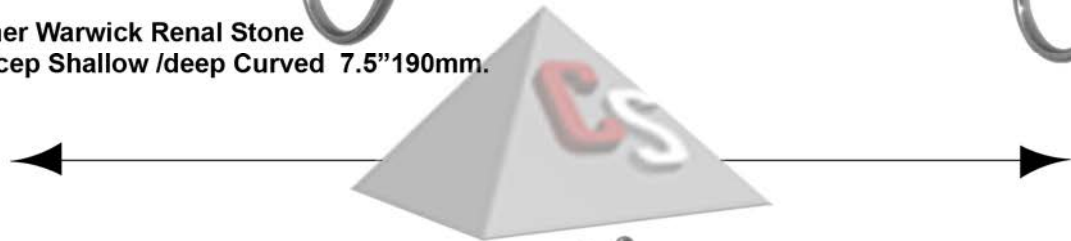

CS-D-011

CS-D-011:Thomson Walker Retractor with 2 Pairs of De-
tachable Wall Blades and Long Blade for Posterior Wall



CS-D-012



CS-D-012: Millan Bladder Retractor Set with 4 Detachable Blades and 1 Center Blade 7" x 5.75"



CS-D-017

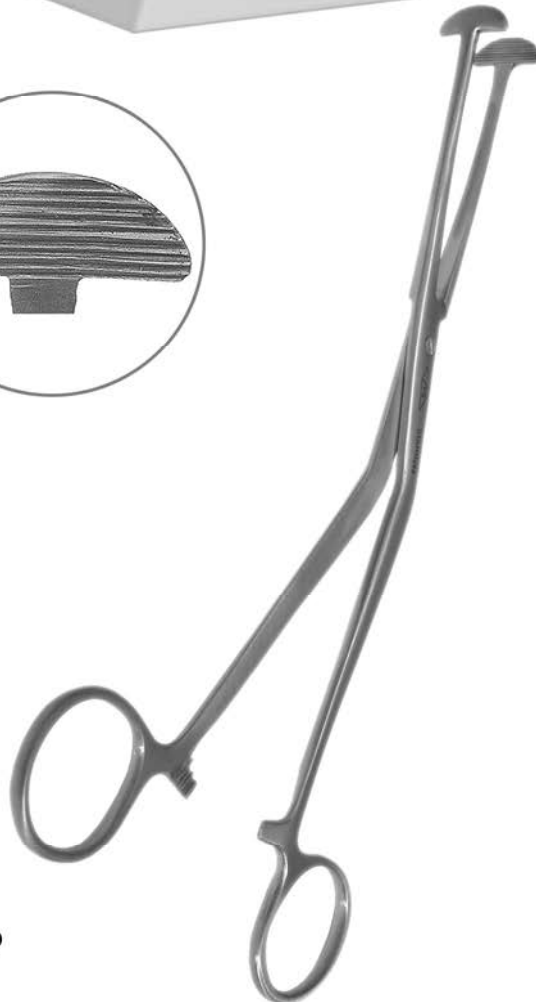

CS-D-017: Millan Prostatic Capsule Forcep T Shape Jaws 9" 230mm.

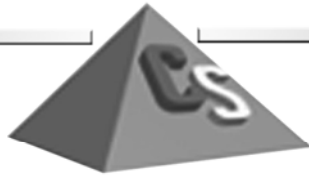

Gynecology

Gynecology



Gynecology





CS-E-001

CS-E-001 : Gwilliam Hysterectomy Forcep
Straight / Curved 8" 200mm.



CS-E-002

CS-E-002 : Heaney Hysterectomy Forcep
Straight / Curved Single Tooth
8" 200mm.



CS-E-003

CS-E-003 : Heaney Hysterectomy Forcep
Straight / Curved Double Tooth 8" 200mm.



CS-E-005

CS-E-005 : Maingot Hysterectomy Forcep
Straight / Curved 1x2 Teeth
8" 200mm.

CS-E-004 : Heaney Hysterectomy Forcep
Straight / Curved Longitudinal serration
8" 200mm.

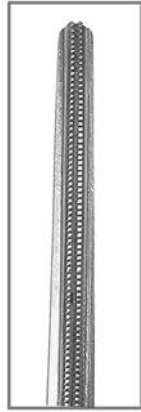

CS-E-009

CS-E-009 : Hysterectomy Forcep with 2x3 Autraumatic Jaws 8" 200mm.



CS-E-010

CS-E-010 : Somers Uterus Holding Forcep Screw Joint 10" 250mm.



CS-E-011

CS-E-011 : Datigues Uterus Holding Forcep 10" 250mm.



CS-E-012

CS-E-012 : Boney Myomectomy Clamp 10.5" 270mm.



CS-E-013



CS-E-013 : Doyen Mymo Screw 6"7" 150mm 175mm.

CS-E-014



CS-E-014 : Auvard Vaginal Speculam (Weighted) (Chromium Plated) 2"x 3.5"



CS-E-016

CS-E-016 : Doyen Rectangular Retractor Small, Medium Large.



CS-E-017

CS-E-017 : Landon Vaginal Retractor Blade 3.5"x1"



CS-E-018

CS-E-018 : Doyen Vaginal Retractor Blade
 $\frac{23}{8}'' \times \frac{31}{2}''$, $\frac{23}{8}'' \times \frac{43}{4}''$



CS-E-020

CS-E-021

CS-E-022

CS-E-019 : Sims Duckbill Speculum (Double Ended) Extra Large.

CS-E-020 : Sims Duckbill Speculum (Double Ended) Large.

CS-E-021 : Sims Duckbill Speculum (Double Ended) Medium.

CS-E-022 : Sims Duckbill Speculum (Double Ended) Small.



CS-E-027

CS-E-027 : Sims Duckbill Speculum(Double Ended) with Fibreoptic Light Source..



CS-E-024

CS-E-024 : Cusco Vaginal Speculum Extra Large.

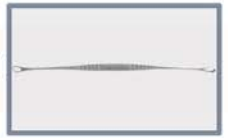

CS-E-029

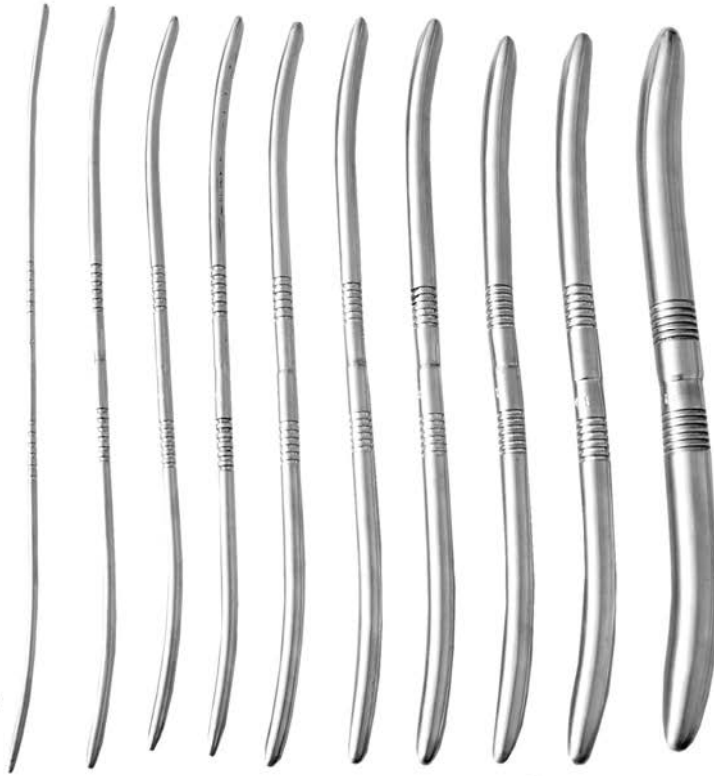

CS-E-029 : Heger Cervix Dilator (Double Ended)
Set of 10. 8.75" 220mm.

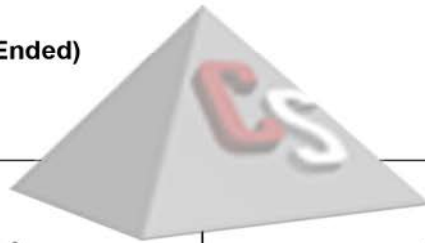

CS-E-032



CS-E-032 : Uterine Curettes Sharp / Blant 9.5" 240mm
Double Ended Tip size: 00,0,1,2,3,4

CS-E-033



CS-E-033 : Uterine Flushing Curettes
Small Medium Large.



CS-E-035

CS-E-035 : Bozemann Uterine Dressing Forcep
10.5" 265mm



CS-E-036

CS-E-036 : Boney Uterine Polypus Forcep
CS-E-037 : Doyen Polypus Forcep 7.25" 180mm.
CS-E-038 : Vant Uterine Polypus Forcep



CS-E-039

CS-E-039 : Schroeder Uterine Volsellum Forcep
10" 255mm 1x1 teeth Tenaculum Forcep



CS-E-040

CS-E-040 : Uterine Volsellum Forcep
2x2 , 3x4 , 4x5 teeth 10" 255mm.

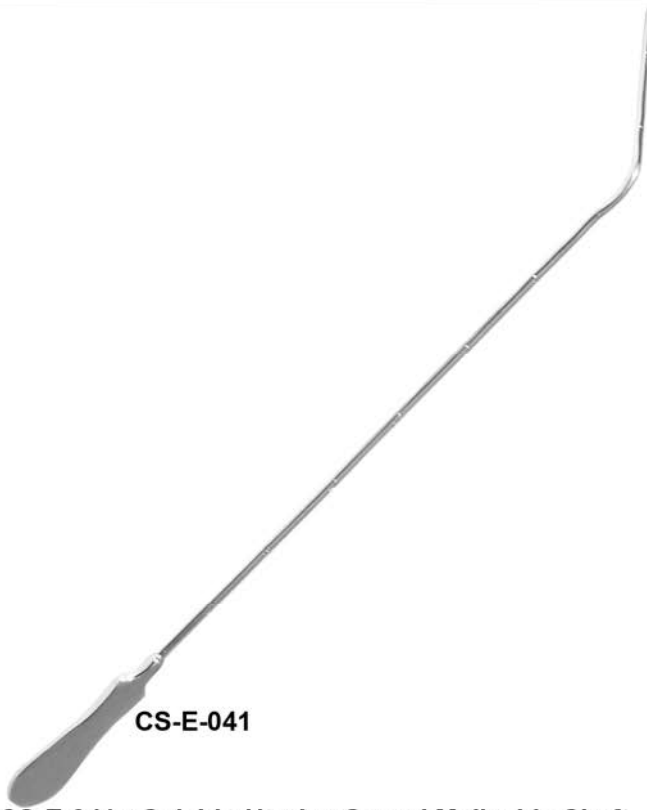
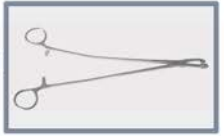

CS-E-041

CS-E-041 : Galabin Uterine Sound Malleable Shaft
Graduated in cms 11" 280mm.

CS-E-042 : Sims Uterine Sound Malleable Shaft
Graduated in cms 11" 280mm.



CS-E-045

CS-E-045 : Novak Suction Curette Luer
10" 250mm

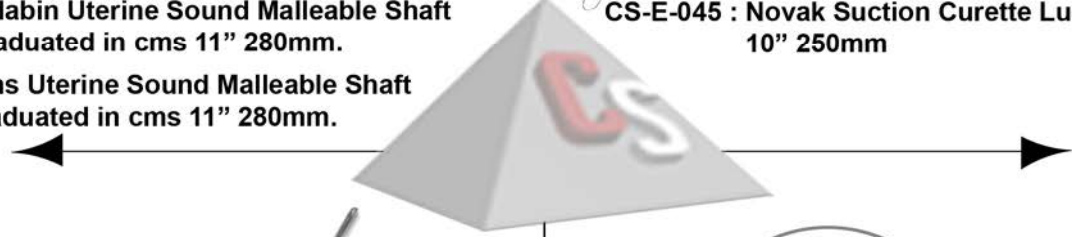

CS-E-046

CS-E-046 : Sharman Endometrial Biopsy
Curette 8.75" 222mm.

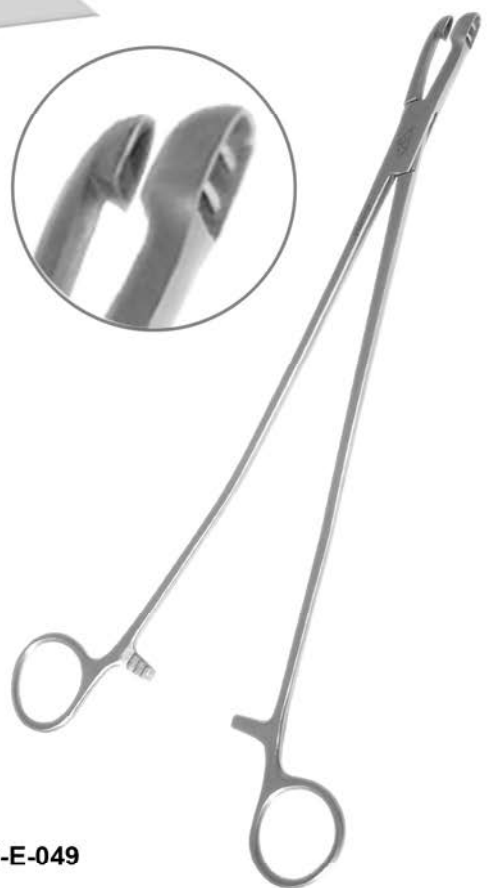

CS-E-049

CS-E-048 : Tischler Biopsy Forcep
Angled Shanks 10.5" 265mm.

CS-E-049 : Vandoren Cervical Biopsy
Punch 10.5" Endometrial Biopsy.

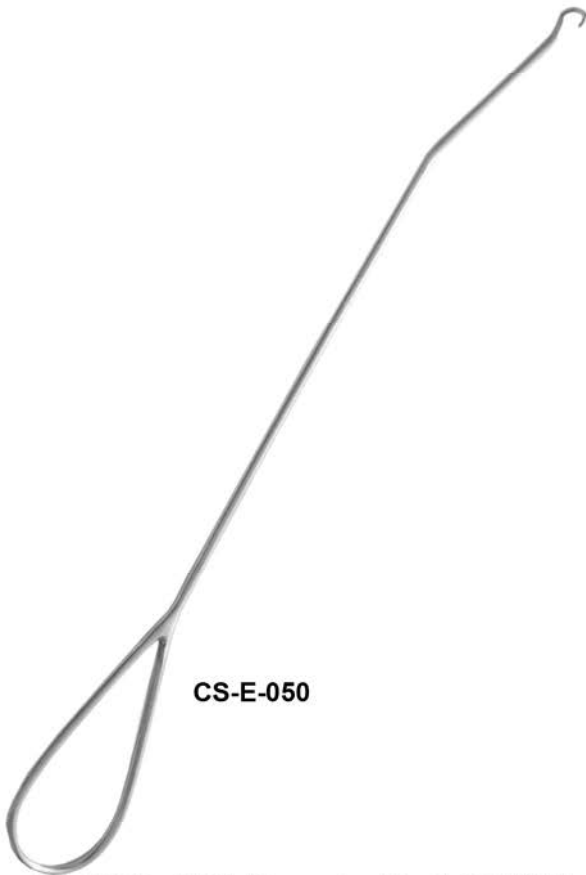
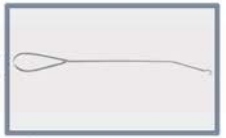

CS-E-050

CS-E-050 : I.U.D. Removing Hook 12.5"305mm.



CS-E-051

CS-E-051 : Leech wilkinson Intra Uterine Cannula with Silette Small , Medium , Large 10.5" 265mm.

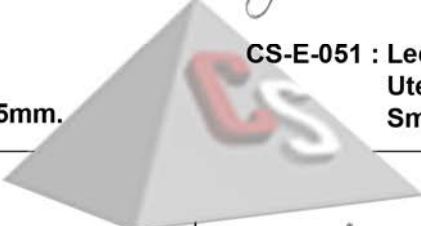

CS-E-060

CS-E-060 : Goodwin Amniotomy Forcep Double curved 10"260mm.



CS-E-061

CS-E-061: M.T.P Cannula 4mm, 6mm, 8mm, 10mm.



CS-E-062

CS-E-062 : Wrigley Obstetric Forceps 11" 280mm.

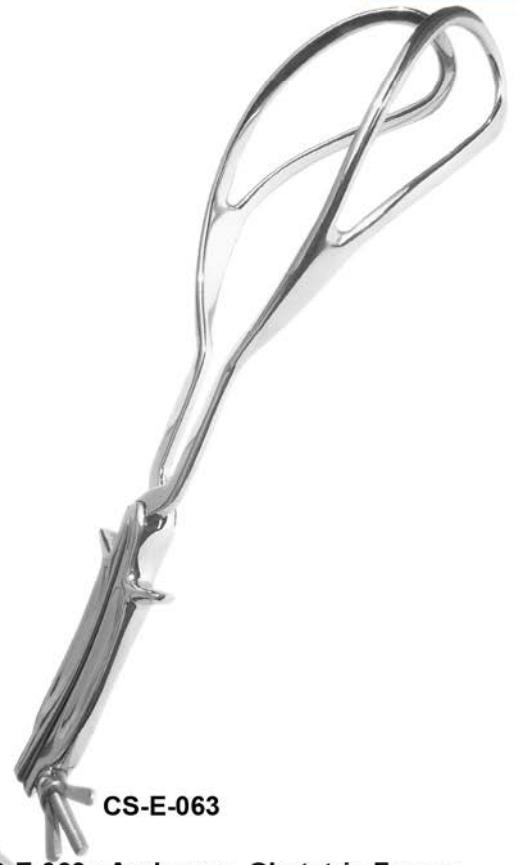

CS-E-063

CS-E-063 : Anderson Obstetric Forceps 15" 380mm.

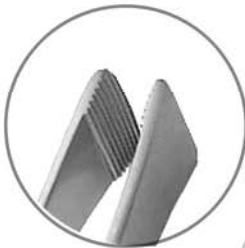

CS-E-066

CS-E-066 : Green-Armytage Haemostasis Clamp 8" 200mm.



CS-E-067

CS-E-067 : Ovum Forceps Cup Type Small/Medium/Large 10" 250mm.



CS-E-068

CS-E-068 : Mc Clintock Ovum Forcep Curved Screw joint 9.5\"/>



CS-E-072

CS-E-072 : American Pattern Umbilical Scissor 4\"/>



CS-E-073

CS-E-073 : Barnes Episiotomy Scissor 6\"/>



CS-E-074

CS-E-074 : Episiotomy Scissor Satin Finish 9.5\"/>



CS-E-075

CS-E-075 : D.N.C Set In Pouch Regular / Exclusive.



Pouch for D.N.C Set.



Cleaning & Maintenance of Surgical Instruments

Chatterjee Surgical manufactures all the surgical instruments under the supervision of specially trained technical staffs and all the instruments go through intensive checking before final packaging. Still we emphasize mostly on cleaning and maintenance to increase the life and working capability of each single instrument. Chatterjee Surgical suggests some interconnected care and maintenance guidelines to all our buyers.

Manual Cleaning (Manual cleaning undergoes some careful stages)

- ⊗ Rinse all the instruments immediately after operation under flowing water to remove all blood, fluids, tissues and other particles.
- ⊗ Submerge instruments into a suitable disinfectant with active cleaning properties so that all surfaces, inner cavities, lumens and openings come into contact with the solution.
- ⊗ The solution should preferably be a combination of distilled water and neutral PH (7) detergent.
- ⊗ Use stiff plastic brushes to clean the remaining and sticky blood stains particularly from hinges, joints, locks, boxes and other malleable parts and working points. Wire brushes may be used in a delicate way for grips, handles, within serrations and jaws (not causing serious damages in working points).
- ⊗ Examine carefully whether instruments are visibly clean and free from blood-stains and tissues.
- ⊗ Test and make sure the instruments are functioning properly.
- ⊗ After scrubbing rinse instruments thoroughly under running water. Final rinsing to be done with distilled or deionized water.
- ⊗ Dry instrument with an absorbent, soft and lint-free cloth.
- ⊗ Dry the instruments in air and store them in a clean and dry environment.

Autoclaving (Autoclaving is essential part before and after all surgeries)

- ⊗ Lubricate all instruments properly.
- ⊗ Steam sterilize using a prevacuum cycle for 4 minutes at a minimum temperature of 132°C(270°F). *Note: Where there is a concern about contamination, the World Health Organization recommends processing through autoclave cycle for 18 minutes at 134°C(273°F).*
- ⊗ Do not overload the autoclave chamber.
- ⊗ Drying time will vary according to load size and should be increased for larger loads.

Always use the proper sterilization /Cleaning technique to render the instrument in required condition for use.

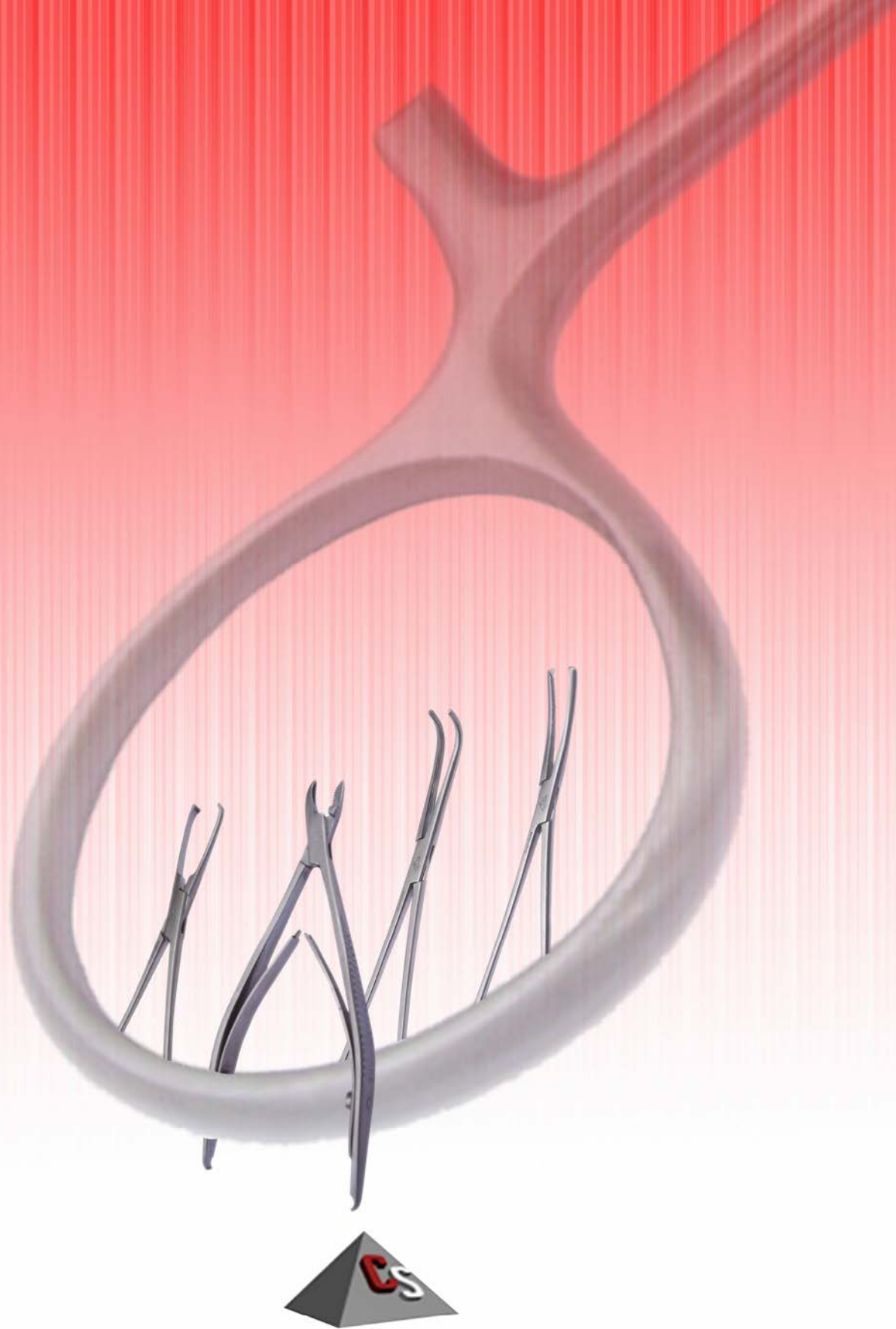

Duttapara , Baruipur , House No. - 108
Behind Hospital , Kolkata - 700144. West Bengal. India.
Tel / Fax : 033-24338737 Tel : 033-24335178, 24335547
Email : chatterji_surgical@vsnl.net, chatterjeesurgical@gmail.com