

# M/S CHATTERJEE SURGICAL KOLKATA



GRUBER  
Aural Specula  
Set of 3



HARTMANN  
Aural Specula  
Set of 4 Black



HARTMANN  
Aural Specula  
Set of 4



HARTMANN  
Aural Specula  
Set of 4 Oval Shape



HOLMGREN  
Self retaining  
Aural Specula



ROSEN Aural Specula  
Set of 4



SHEA Aural Specula  
Set of 4



ROSEN AURAL  
Slotted Specula  
Set of 4



TUMARKIN TAPERED  
Slotted Aural Specula  
Set of 4



AURAL SYRING  
All Metal with  
2 Pipes Conical and  
Bulbous Pipes



SIEGLE PNEUMATIC  
Speculum Set of 4

# M/S CHATTERJEE SURGICAL KOLKATA

1012-1017



Size
1012 128
1013 256
1014 512
1015 1024
1016 2048
1017 4096

GARDINER  
Tuning Forks

1018



EUSTACHIAN  
Catheters

1019



FORMBY  
Cerumen Scoop and Hook

1020-21



JOBSON  
Horn Probes

1022



HOVELL  
Wax Loop Remover

1023



FOREIGN BODY  
Removing

1024



FOREIGN BODY  
and Hard Wax  
Removing

1025-1026



RING  
Curette Buck

1027



WAGENER HOOK  
Delicate

1028



WIRE  
Wax Remover

1029



FAGGE AURAL  
Forceps Plain

1030



FAGGE AURAL  
Forceps with 1x2  
Teeth

1031



WILDE AURAL  
Forceps

# M/S CHATTERJEE SURGICAL KOLKATA

1032



ADSON  
Forceps Plain

1033



ADSON FORCEPS  
with 1x2 Teeth

1034



OSSICLE  
Holding Clamp

1035



HARTMANN  
Aural Forceps

1036



TILLEY  
Aural Forceps

1037



Straight

1038



Curved  
Delicate



LEMPERT  
Rongeur

1039



LEMPERT  
Endaural Speculum

1040



GLEGG  
Aural Snare

# M/S CHATTERJEE SURGICAL KOLKATA

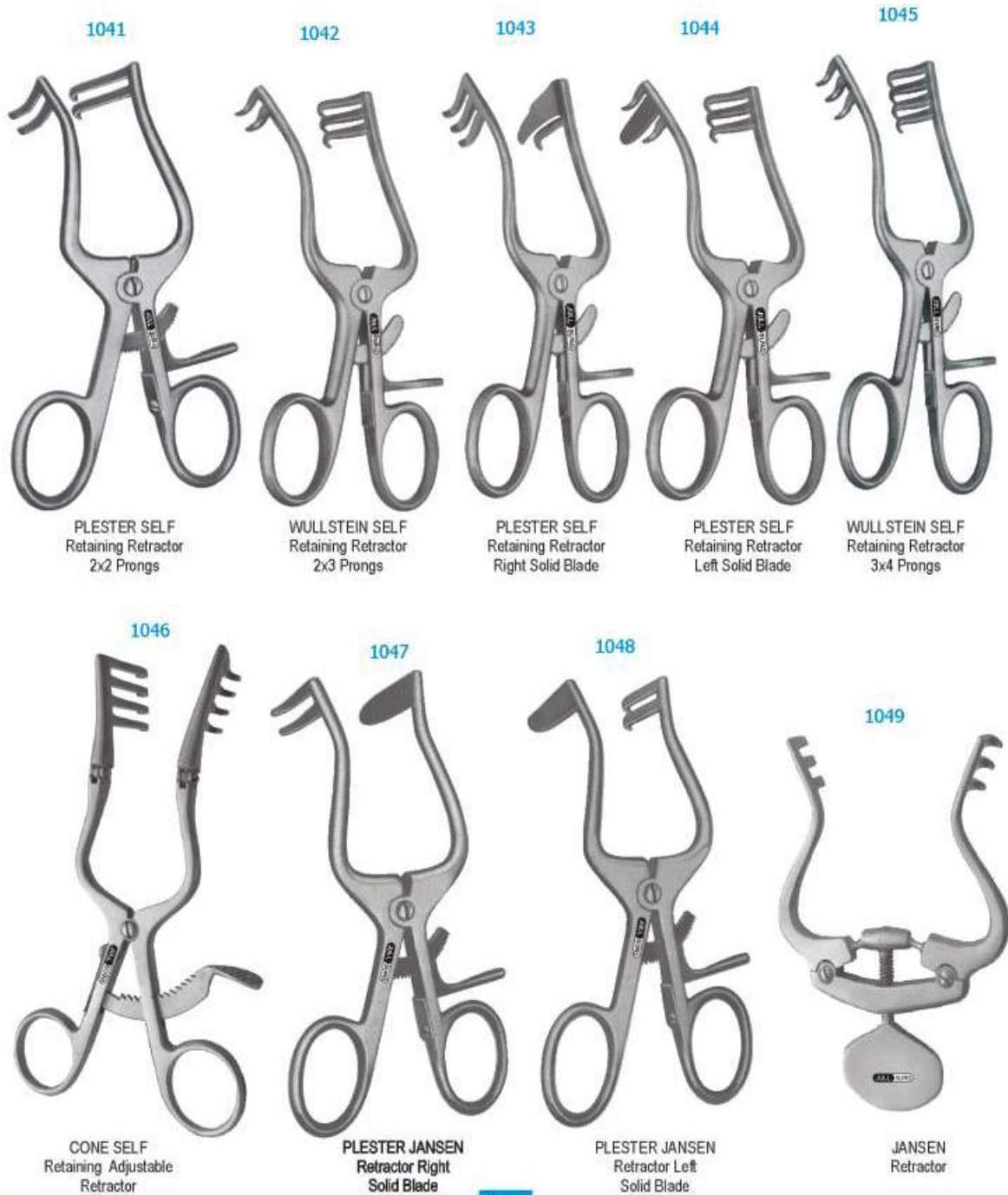

# M/S CHATTERJEE SURGICAL KOLKATA

1050-54



LEMPERT  
Mastoid Curette

1055-60



JANSEN CHISEL  
140mm

1061-66



JANSEN OSTEOTOME  
140mm

1067-72



JENKINS GOUGE  
140mm

1073



Straight



FARABEU ELEVATOR  
Straight & Curved

1074



Curved

- 1050 2mm
- 1051 3mm
- 1052 4mm
- 1053 5mm
- 1054 6mm

- 1055 2mm
- 1056 3mm
- 1057 4mm
- 1058 6mm
- 1059 8mm
- 1060 10mm

- 1061 2mm
- 1062 3mm
- 1063 4mm
- 1064 6mm
- 1065 8mm
- 1066 10mm

- 1067 2mm
- 1068 3mm
- 1069 4mm
- 1070 6mm
- 1071 8mm
- 1072 10mm

1075-76



KERRISON PUNCH  
Upward Cutting

- 1075 1mm
- 1076 2mm

1077



LAKE  
Seeker

1078



HOUSES GRAFT  
Press Forceps

1079



TEMPORAL  
Bone Holder



# M/S CHATTERJEE SURGICAL KOLKATA

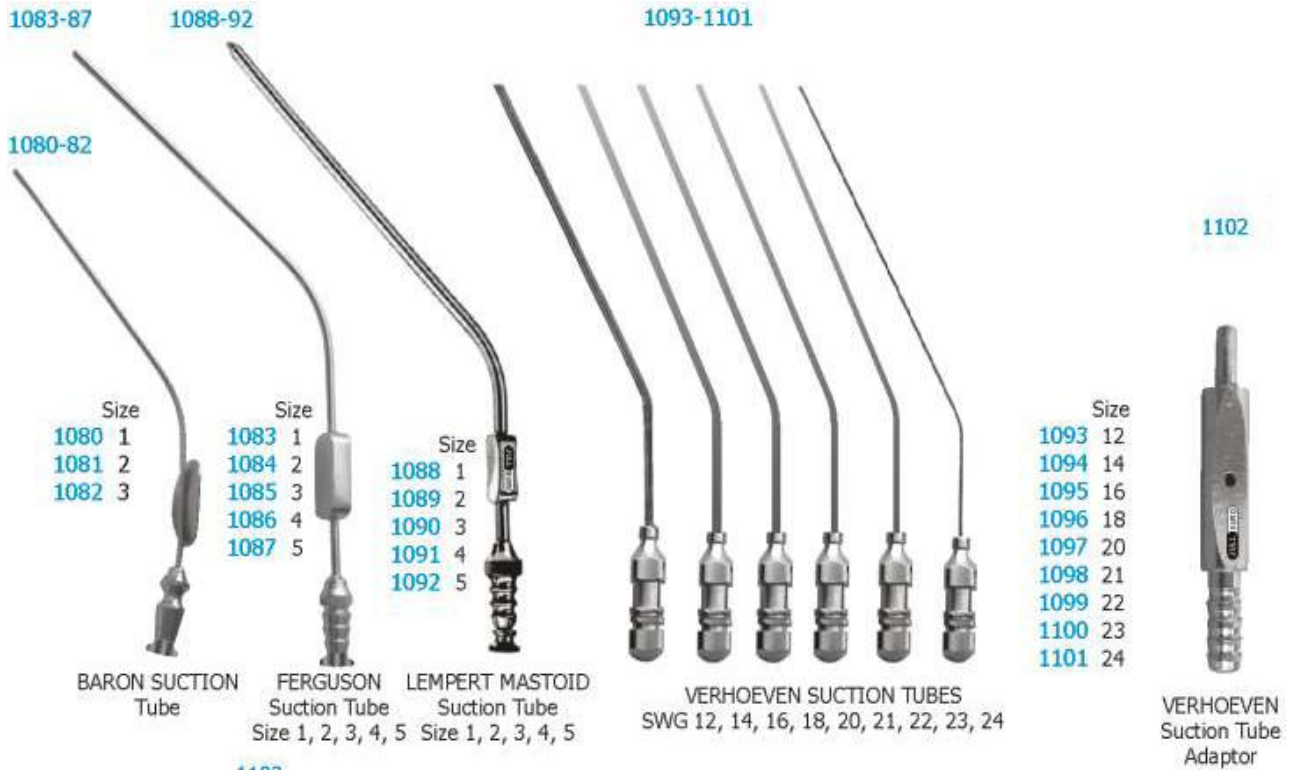

MICRO INSTRUMENTS  
Perforator Tray for 5 Points



MICRO INSTRUMENT RACK  
for 12 Points



MICRO INSTRUMENTS TRAY  
For Forceps & Point  
with Silicone Matt

# M/S CHATTERJEE SURGICAL KOLKATA



FINE STRAIGHT



LEFT CURVED



RIGHT CURVED



FINE UPWARD



FINE 1x2 TEETH



FINE STRAIGHT



FINE LEFT  
Curved



FINE RIGHT  
Curved



FINE UPWARD



FINE STRAIGHT



LEFT CURVED



RIGHT CURVED



FINE UPWARD



M/S CHATTERJEE SURGICAL  
KOLKATA

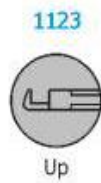
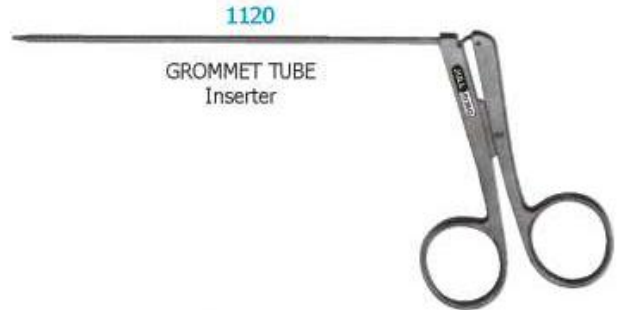



# M/S CHATTERJEE SURGICAL KOLKATA

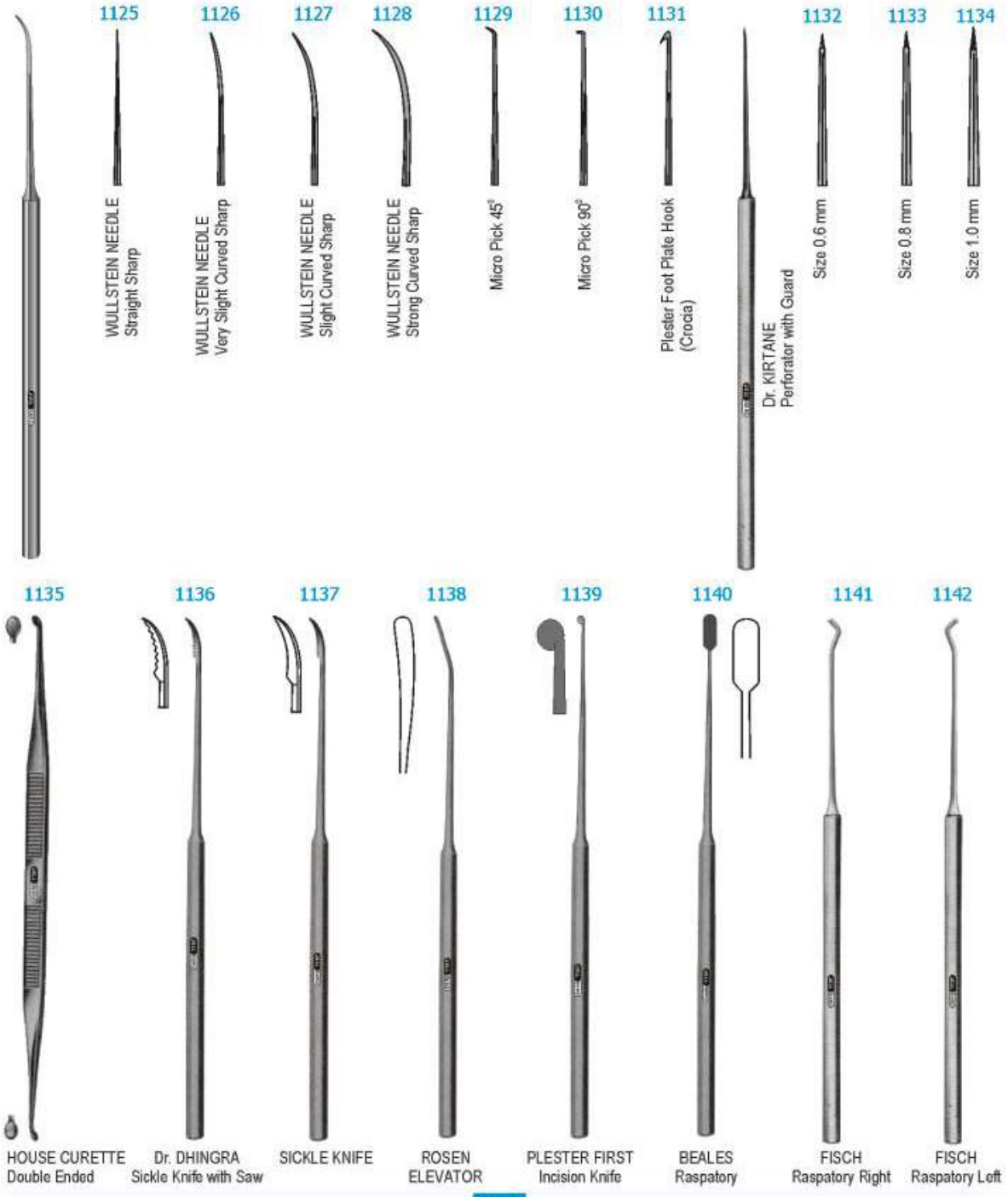

# M/S CHATTERJEE SURGICAL KOLKATA

1143



MYRINGOTOMY  
Knife

1144



ROSEN  
Curette

1145



ROSEN CURETTE  
Double Curved

1146



ROSEN CURETTE  
Curved

1147



CIRCULAR CUTTING  
Knife 60°

11148



CIRCULAR CUTTING  
Knife Curved

1149



CIRCULAR KNIFE  
with Hole

1150



BALL  
PROBE

1151



LARKIN PENETRATOR  
Burr

1152



HOUSE MEASURING RODS  
3.5, 4.0, 4.5mm

1153



SHEA PISTON DEPTH  
Gauge 3.5, 4.0, 4.5 mm

1154



MEASURING  
JIG

# M/S CHATTERJEE SURGICAL KOLKATA



KILLIAN NASAL SPECULUM  
5 cm, 6.5 cm, 7.5 cm, 9 cm

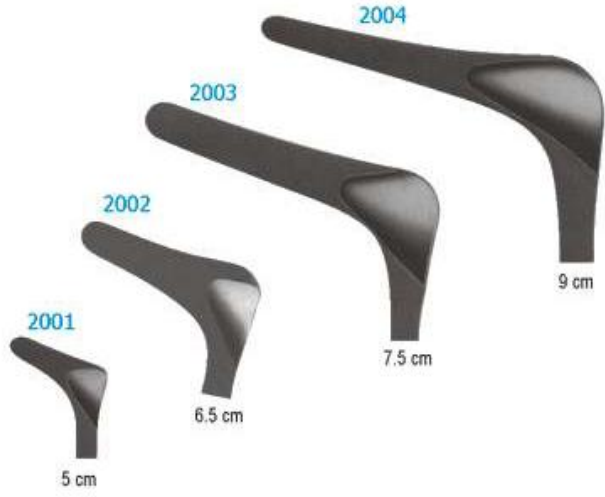

2001

5 cm

2002

6.5 cm

2003

7.5 cm

2004

9 cm



2005

HARTMANN  
Nasal Speculum



KILLIAN NASAL  
Speculum  
with Fiber Light



2007

ST. CLAIR THOMSON  
Nasal Speculum Set of 4



2008

THUDICHUM  
Nasal Speculum  
Set of 3

# M/S CHATTERJEE SURGICAL KOLKATA

2009



COTTLE  
Retractor  
Blunt

2010



COTTLE  
Retractor  
Sharp

2011



GILLIES  
Skin Hook

2012



COTTLE UPER LATERAL  
Exposing Retractor

2013



ALAR  
Retractor

2014



KILNER  
Retractor

2015



DISSECTOR  
with Succer

2016



Dr. DHINGRA  
Retractors

2017



FREER  
Elevator

2018



SMR ELEVATOR  
Broad

2019



SMR ELEVATOR  
Fine

2020



COTTLE ELEVATOR  
Slight Curved

2021



MASING  
Elevator with  
Graduated

# M/S CHATTERJEE SURGICAL

## KOLKATA

2096



JOSEPH KNIFE  
Curved

2097



STRAIGHT

2098



JOSEPH NASAL  
Saw Left

2099



RIGHT

2100



MALTZ  
Rasp

2101



JOSEPH NASAL  
Rasp Fine

2102



AUFRIGHT  
Nasal Rasp

2103



JOSEPH NASAL  
Rasp

2104



MALLET

2105



DR. V.P. SOOD  
Hook

2106



DR. V.P. SOOD  
Love Retractor

2107



ROSS  
Raspatory Left

2108



ROSS  
Raspatory Right



# M/S CHATTERJEE SURGICAL KOLKATA



NASAL SCISSORS,  
Serrated Blades, Working  
Length 13 cm,



BLAKESLEY NASAL  
Forceps



THROUGH CUTTING Frontal Sinus  
Punch Forceps 55° Double Action  
Cup 2mm Working Length 14.5cm



ANTRUM PUNCH, Backward  
Cutting, Working Length 13mm

# M/S CHATTERJEE SURGICAL KOLKATA



NASAL SCISSORS,  
Serrated Blades, Working  
Length 13 cm,



BLAKESLEY NASAL  
Forceps



THROUGH CUTTING Frontal Sinus  
Punch Forceps 55° Double Action  
Cup 2mm Working Length 14.5cm



ANTRUM PUNCH, Backward  
Cutting, Working Length 13mm

# M/S CHATTERJEE SURGICAL KOLKATA

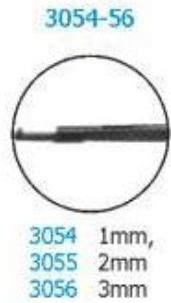

ANTRUM PUNCH,  
through-Cutting wide  
1mm, 2mm, 3mm Workign  
Length 13mm, With Reservoir  
to Pick up and collect bone material



# M/S CHATTERJEE SURGICAL KOLKATA

4001



TONGUE DEPRESSOR  
Set of 3

4002



NEGUS TONSIL  
Artery Forceps Half Curved

4003



NEGUS TONSIL  
Artery Forceps Full Curved

4004

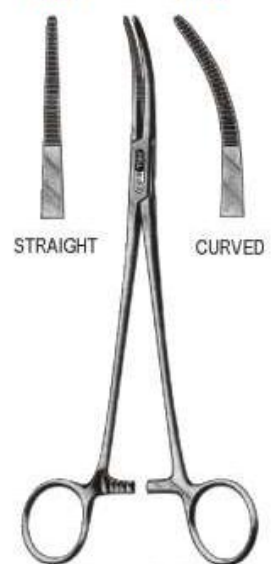

BIRKETT TONSIL  
Artery Forceps

4005

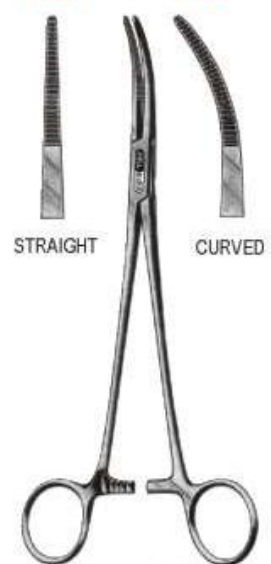

STRAIGHT

CURVED

4006



WOODS TONSIL  
Scissors Straight

4007



WOODS TONSIL  
Scissors Curved

4008



DENIS BROWNE  
Tonsil Holding  
Forceps

4009



COLVER TONSIL  
Holding Forceps

4010



TONSIL NEEDLE  
Holder

# M/S CHATTERJEE SURGICAL KOLKATA





# M/S CHATTERJEE SURGICAL KOLKATA

4030



BOYLE DAVIS MOUTH GAG  
with 3 Tongue Plates **CHILD**

4031



BOYLE DAVIS MOUTH GAG  
with 4 Tongue Plates **ADULT**

4032



DOUGHTY  
Slotted Mouth Gag  
with 4 Tongue Plates

4033

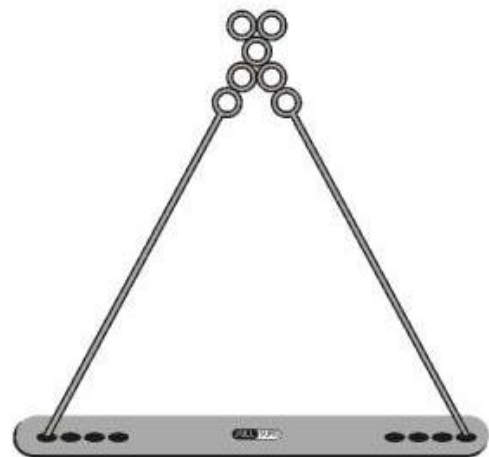

DRAFFIN BIPOD STAND  
with Plate

M/S CHATTERJEE SURGICAL  
KOLKATA

4034



DINGMAN MOUTH  
Gag with 3 Tongue Plates



4035



HEISTER  
Mouth Gag

4036



JENNINGS  
Mouth Gag

4037



DOYAN MOUTH GAG

4037 Adult

4038 Child

# M/S CHATTERJEE SURGICAL KOLKATA

5001-5



- 5001 1
- 5002 2
- 5003 3
- 5004 4
- 5005 5

5006-10



- 5006 1
- 5007 2
- 5008 3
- 5009 4
- 5010 5

5011



5012



TONGUE HOLDING  
Forceps

5013



BACKHAUS TOWEL  
Forceps

- 5001 Laryngeal Mirrors without handle  
No. 1, 2, 3, 4, 5
- 5002 Post Rhinoscopic Mirror without Handle No. 1,2,3,4,5
- 5003 Mirror Handle

5014-15



- 5014 Small
- 5015 Medium

LANGEN BECK  
Retractor  
Small, Medium

5016



- 5016 3 Prong
- 5017 4 Prong

YOLKMANN  
Retractor 3 Prongs  
Sharp

5017



4 Prongs  
Sharp

5018



Small  
5019



Medium  
5020



Large

MAGILL INTRATRACHEAL  
Catheter Forceps

5021



TRACHEAL DILATING  
Forceps













5022



TOWEL CLIP  
Cross Section

# M/S CHATTERJEE SURGICAL KOLKATA

<p>5023</p>  <p>TRACHEAL RETRACTOR 1 Prongs Sharp</p>	<p>5024</p>  <p>TRACHEAL Retractor 1 Prongs Blunt</p>	<p>5025</p>  <p>TRACHEAL RETRACTOR 2 Prongs Blunt</p>	<p>5026-35</p>  <p>FULLER TRACHEOTOMY TUBE All Metal</p> <table border="0"> <tr><td>5026</td><td>18 FG</td></tr> <tr><td>5027</td><td>20 FG</td></tr> <tr><td>5028</td><td>22 FG</td></tr> <tr><td>5029</td><td>24 FG</td></tr> <tr><td>5030</td><td>26 FG</td></tr> <tr><td>5031</td><td>28 FG</td></tr> <tr><td>5032</td><td>30 FG</td></tr> <tr><td>5033</td><td>32 FG</td></tr> <tr><td>5034</td><td>34 FG</td></tr> <tr><td>5035</td><td>36 FG</td></tr> </table>	5026	18 FG	5027	20 FG	5028	22 FG	5029	24 FG	5030	26 FG	5031	28 FG	5032	30 FG	5033	32 FG	5034	34 FG	5035	36 FG	<p>5036-51</p>  <p>JACKSON TRACHEOTOMY Tube All Metal</p> <table border="0"> <tr><td>5036</td><td>12 FG</td><td>5044</td><td>28 FG</td></tr> <tr><td>5037</td><td>14 FG</td><td>5045</td><td>30 FG</td></tr> <tr><td>5038</td><td>16 FG</td><td>5046</td><td>32 FG</td></tr> <tr><td>5039</td><td>18 FG</td><td>5047</td><td>34 FG</td></tr> <tr><td>5040</td><td>20 FG</td><td>5048</td><td>36 FG</td></tr> <tr><td>5041</td><td>22 FG</td><td>5049</td><td>38 FG</td></tr> <tr><td>5042</td><td>24 FG</td><td>5050</td><td>40 FG</td></tr> <tr><td>5043</td><td>26 FG</td><td>5051</td><td>42 FG</td></tr> </table>	5036	12 FG	5044	28 FG	5037	14 FG	5045	30 FG	5038	16 FG	5046	32 FG	5039	18 FG	5047	34 FG	5040	20 FG	5048	36 FG	5041	22 FG	5049	38 FG	5042	24 FG	5050	40 FG	5043	26 FG	5051	42 FG
5026	18 FG																																																							
5027	20 FG																																																							
5028	22 FG																																																							
5029	24 FG																																																							
5030	26 FG																																																							
5031	28 FG																																																							
5032	30 FG																																																							
5033	32 FG																																																							
5034	34 FG																																																							
5035	36 FG																																																							
5036	12 FG	5044	28 FG																																																					
5037	14 FG	5045	30 FG																																																					
5038	16 FG	5046	32 FG																																																					
5039	18 FG	5047	34 FG																																																					
5040	20 FG	5048	36 FG																																																					
5041	22 FG	5049	38 FG																																																					
5042	24 FG	5050	40 FG																																																					
5043	26 FG	5051	42 FG																																																					

<p>5052</p>  <p>BARD PARKER HANDLE No. 3</p>	<p>5053</p>  <p>BARD PARKER Handle No. 4</p>	<p>5054</p>  <p>BARD PARKER Handle No. 7</p>	<p>5055</p>  <p>10</p>	<p>5056</p>  <p>11</p>	<p>5057</p>  <p>12</p>	<p>5058</p>  <p>15</p>	<p>5059</p>  <p>20</p>
			<p>5060</p>  <p>21</p>	<p>5061</p>  <p>22</p>	<p>5062</p>  <p>23</p>	<p>5063</p>  <p>24</p>	

BARD PARKER BLADES  
No. 10, 11, 12, 15, 20, 21, 22, 23, 24

# M/S CHATTERJEE SURGICAL KOLKATA

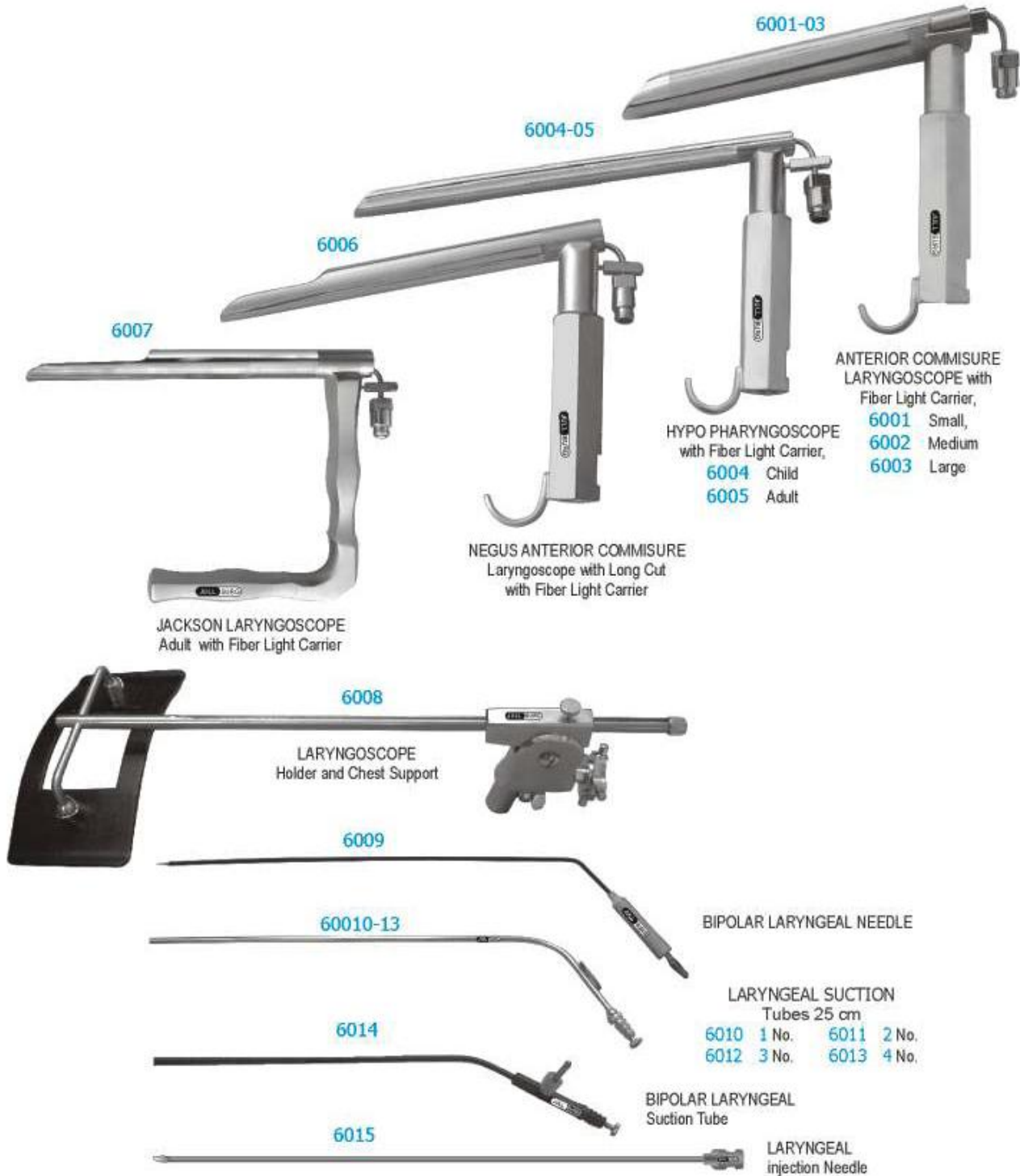



# M/S CHATTERJEE SURGICAL KOLKATA



**6016-17**  
MICRO LARYNGEAL  
Forceps Serrated Jaw  
6016 25 cm  
6017 35cm



**6018**  
MICRO LARYNGEAL  
Forceps Serrated Jaw  
Curved Right 25 cm



**6019**  
MICRO LARYNGEAL  
Forceps Serrated Jaw  
Curved Left Size 25 cm



**6020**  
MICRO LARYNGEAL  
Forceps Serrated Jaw  
Upward Size 25 cm



**6021-22**  
MICRO LARYNGEAL  
Forceps Cup Jaw Straight  
6021 25 cm  
6022 35 cm



**6023**  
MICRO LARYNGEAL  
Forceps Cup Jaw Curved Right  
Size 25 cm



**6024**  
MICRO LARYNGEAL  
Forceps Cup Jaw Curved Left  
Size 25 cm



**6025**  
MICRO LARYNGEAL  
Forceps Cup Jaw  
Upward Size 25 cm



**6026**  
MICRO LARYNGEAL  
Scissors Straight  
Size 25 cm



**6027**  
MICRO LARYNGEAL  
Scissors Curved Right  
Size 25 cm



**6028**  
MICRO LARYNGEAL  
Scissors Curved Left  
Size 25 cm



**6029-32**  
PATTERSON BIOPSY  
Forceps  
6029 Size 25 cm  
6030 Size 35 cm  
6031 Size 45 cm  
6032 Size 55 cm



**6033-36**  
JACKSON GRASPING  
Forceps  
6033 Size 25 cm  
6034 Size 35 cm  
6035 Size 45 cm  
6036 Size 55 cm



**6037-40**  
JACKSON FOREIGN  
Body Forceps  
6037 Size 25 cm  
6038 Size 35 cm  
6039 Size 45 cm  
6040 Size 55 cm



**6041-44**  
VOCAL NODULE FORCEPS  
6041 Size 25 cm  
6042 Size 35 cm  
6043 Size 45 cm  
6044 Size 55 cm



**6045-48**  
BIOPSY PUNCH  
Forceps  
6045 Size 25 cm  
6046 Size 35 cm  
6047 Size 45 cm  
6048 Size 55 cm

## 6049-54



BRONCHOSCOPE with Fiber Light Carrier	6049	4MM X 27MM	6050	5 MM X 30MM
	6051	7MM X 35MM	6052	8 MM X 40MM
	6053	9MM X 45MM	6054	12MM X 50MM

## 6055-60



OESOPHAGOSCOPE with Fiber Light Carrier	6055	4MM X 27MM	6056	5 MM X 30MM
	6057	7MM X 35MM	6058	8 MM X 40MM
	6059	9MM X 45MM	6060	12MM X 50MM

## 6061-63



BRONCHOSCOPE  
Suction Tubes  
6061 35 cm  
6062 45 cm  
6063 55 cm

# M/S CHATTERJEE SURGICAL KOLKATA

6075



MICRO FORCEPS  
Plain

6076



1 x 2 Teeth

6077



Jewellers Micro  
Forceps No. 3

6078



Bipolar Coagulation  
Forceps Bayonet Type

6079



Bipolar Coagulation  
Forceps Straight

6080



Bipolar Coagulation  
Forceps Curved

6081



MICRO SPRING  
Scissors Straight

6082



MICRO SPRING  
Scissors Curved

6083



MICRO SPRING NEEDLE  
Holder Straight

6084



MICRO SPRING NEEDLE  
Holder Curved

6085



CHEATTLE  
Forceps

6086



CHEATTLE  
Jar

# M/S CHATTERJEE SURGICAL KOLKATA

6103



FIBER OPTIC  
HEAD LIGHT  
Band

6104



FIBER OPTIC CABLE  
6104 3.5 mm length 230 cm  
6105 4.5 mm length 230 cm

6106



FIBER OPTIC COLD LIGHT SOURCE  
DOUBLE POINT 24 V - 250 W

6107



FIBER OPTIC COLD LIGHT SOURCE  
SINGLE POINT 15 V - 150 W

6108



MURPHY HEAD  
Mirror

6109



BULLS EYE LAMP  
Folding

6112



FLEXIBLE EXAMINE LIGHT  
Fiber Optic

6110



CLAR HEAD LIGHT

6111



TRANSFORMER FOR  
Head Light