

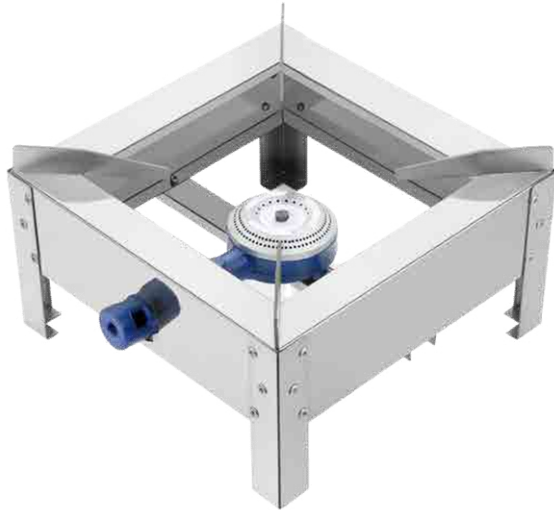

SME OCEANWAYS

Where Quality Meets Global Trade.



01

Square Stove

10x10 | 12x12 | 15x15 | 18x18



02

Round Stove

10" | 12" | 15"

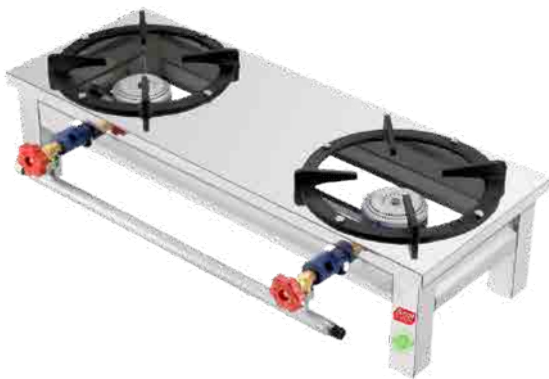

03

Double Stove

10x26 | 11x30 | 12x30



04

Gas Burner

Bottom Burner | Head Burner | Cup
Burner | Canteen Burner

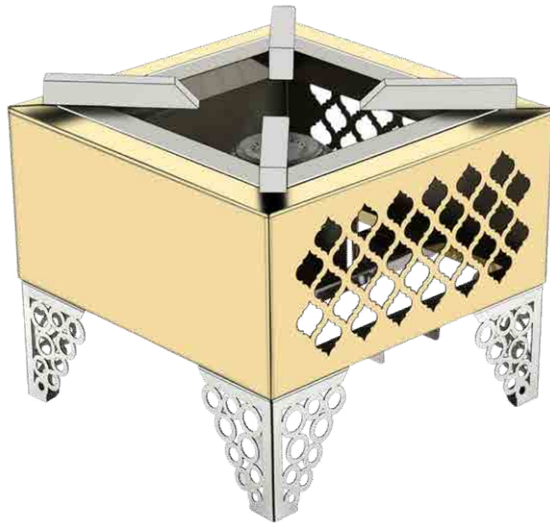

05

Golden Stove

10x10 | 12x12 | 15x15



06

Potato Finger Chipser

7mm Blade



07

Dosa Bhatti

15x36x13 | 18x36x13

24x36x13 | 24x48x13

Customization Also Available



08

Chapati Bhatti

15x36x13 | 18x36x13

24x36x13 | 24x48x13

Customization Also Available



SME OCEANWAYS

CATALOGUE

of our new collection



09

Shawarma Machine Cabinet

With Stainless Steel Road + Lockable Plate
Cylinder Area
Cash Drawer Also



10

Shawarma Machine Table Top
With Stainless Steel Road +
Lockable Plate



11

Shawarma Machine With Table
With Stainless Steel Road +
Lockable Plate
Cylinder Area



SME OCEANWAYS

CATALOGUE

of our new collection



12

Three Burner Gas Range

Indian Chinese Optional
Dimension = 24x60x30
Customization Available



13

Single Burner Gas Range

Indian Chinese Optional
Dimension = 24x24x30
Customization Available



14

Two Burner Gas Range

Indian Chinese Optional
Dimension = 24x46x30
Customization Available



15

Compact Idli Steamer

4 tray | 6 tray



16

Commercial Idli Steamer

4 to 14 Trays



17

Cast Iron Griller Plate

Also Work In Our Dosa Bhatti



18

Chopping Boards

Square | Rectangle | Oval | Customize



19

Sweet Tray / Choki
As per Customer Requirement



20

Dosa Tawa
Southern Based



21

Handi Stove
More Power In Cooking With The
Korean Burner



22

Rotter Dosa Bhatti
Caterer's Favorite
Available In Customize Option



SME OCEANWAYS

CATALOGUE

of our new collection



23
Sink Unit
Single | Double | Tripple
With Fountain Also



24
Hot Bowl Bain Marie
Customize In Every Steps
Up to 10 Bowl Capacity
Electric + Gas Compatibility



25
Working Table
Single Shelf | Two Shelf | Three Shelf
Upper Shelf
With Compartment



SME OCEANWAYS

CATALOGUE

of our new collection



26

Tandoor Bhatti

32x32 Premium Size
Charcoal Based
Gas Based



27

Stainless Steel Naan Stamp

Roghini Bread Based

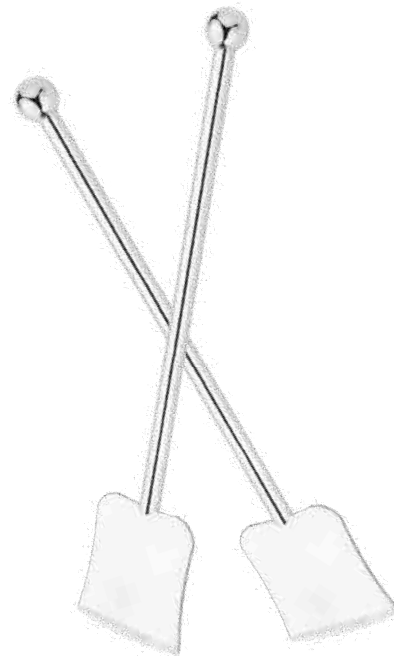

28

Stainless Steel Palta

As Per Customer Requirement

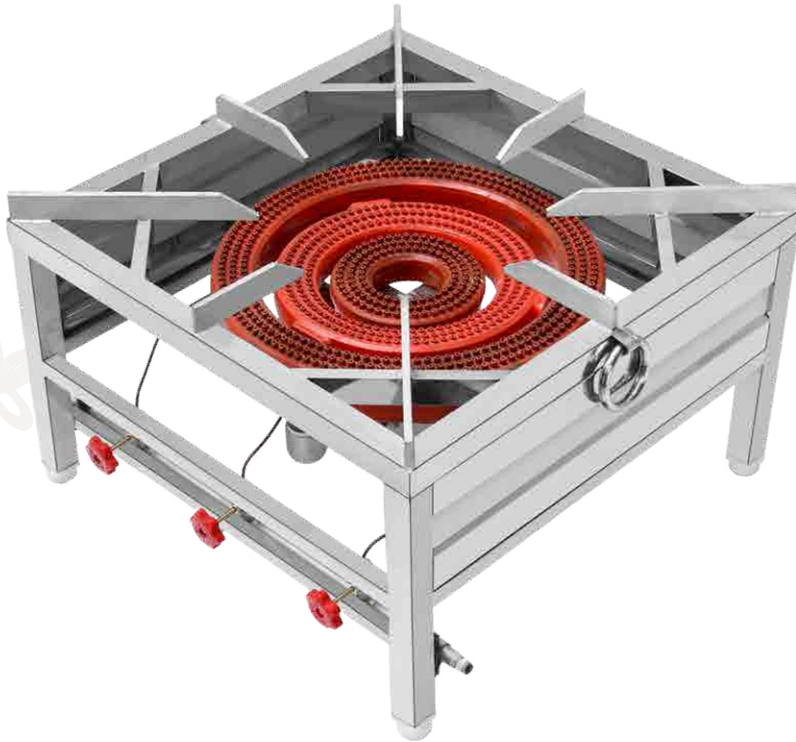

29

Three Burner Korean Stove
30x30x16
Best For Pandal, Big Kitchen
And Chemical Industries

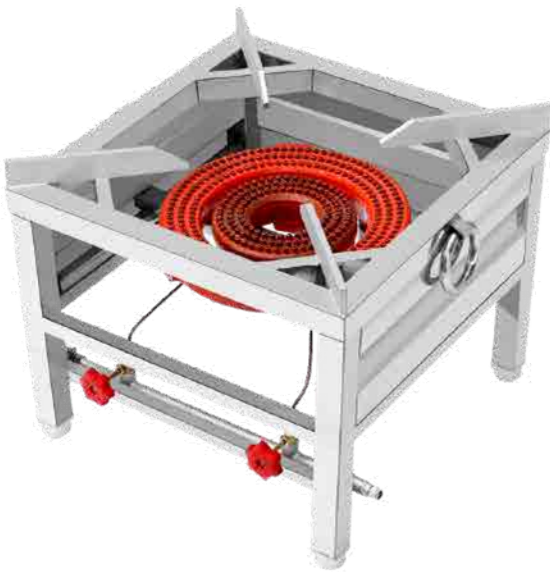

30

Two Burner Korean Stove
24x24x16
Best For Biryani Making Process

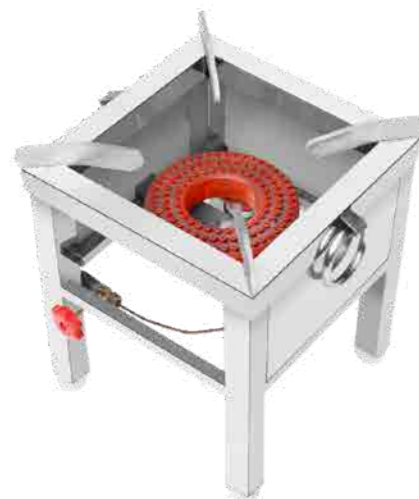

31

Single Burner Korean Stove
18x18x16
Best For Mini Kitchen



SME OCEANWAYS

CATALOGUE

of our new collection



32

Food Cart

Vada Pau Counter

Panipuri Counter

Everything Customized

33

Food Cart

Paubhaji Counter

Fried Veggies Counter

Everything As Per Customer

Requirement





34

Charcoal Shawarma

Stainless Steel Body + Up To 20 Kgs
At A Time



35

Pizza Pillar

As Per Customer Requirement



36

Spatula

Plain | Wide | Hole
As Per Customer Requirement



37

Bhaji Messer

As Per Customer Requirement



SME OCEANWAYS



Contact Details :

☎ +91 82175 24980

✉ smeoceanways@gmail.com

🌐 www.smeoceanways.com

📷 @smeoceanways

📺 smeoceanways

📘 Sme Oceanways