

THINK | CLADDING | THINK

ALSTONE[®]

Standard Louvers | Ventilated Fin Louvers

Kartik's Choice!

ALSTONE[®]
LOUVERS

LIMITLESS AS YOUR IMAGINATION

P R E M I U M E X T E R I O R & I N T E R I O R C L A D D I N G

THE LEGACY OF
TWO DECADES OF
DELIVERING OVER 700+
MILLION SQ FT OF MCPs,
NOW DELIVERS EVEN MORE.

THINK **CLADDING** THINK

ALSTONE[®]



21+
YEARS OF
TRUST

700+
MILLION SQ FT
OF MCP DELIVERED

500+
CHANNEL
PARTNERS

300+
PRIMARY
SHADES

17
OFFICES
PAN INDIA

About **Alstone**

Alstone Louvers - Limitless as Your Imagination

Alstone Louvers combine modern aesthetics with superior performance, offering architects and Interior designers the freedom to create facades that inspire. Engineered with precision and backed by Alstone's two decades of expertise, they ensure durability, weather resistance, and low maintenance for lasting elegance.

Available in an extensive range of finishes, colors, and profiles, Alstone Louvers provide unmatched design versatility perfect for bold, timeless, and functional elevations. Manufactured in state-of-the-art facilities to global quality standards, they are the trusted choice of leading architects and builders for commercial, residential and institutional landmarks.

THINK **CLADDING** THINK
ALSTONE®



**ALSTONE[®]
LOUVERS**
LIMITLESS AS YOUR IMAGINATION

CATEGORY

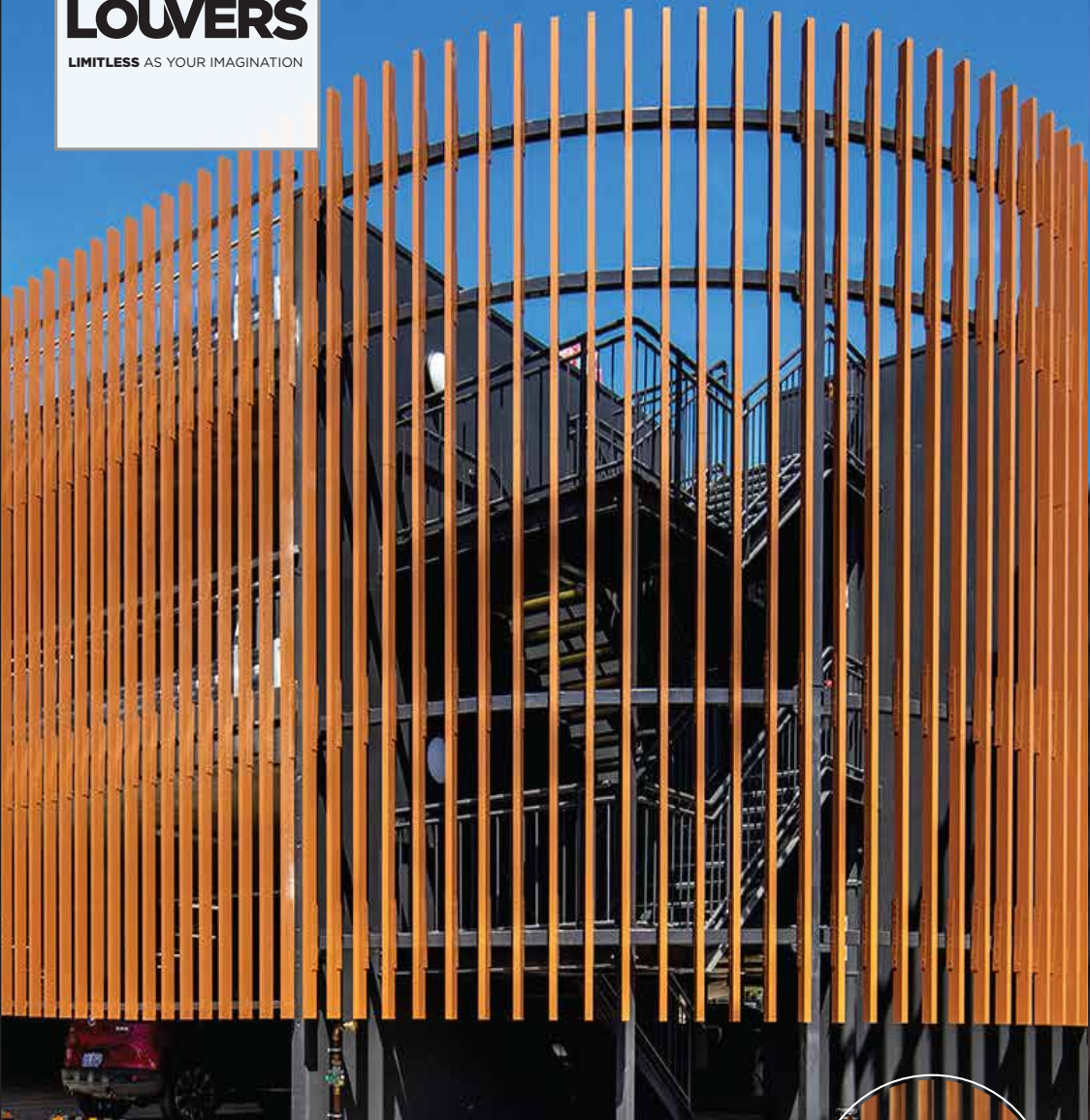

Ⓐ Ventilated Fin Louvers

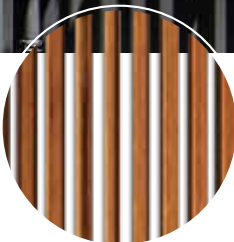



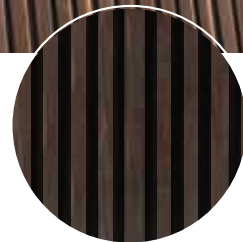

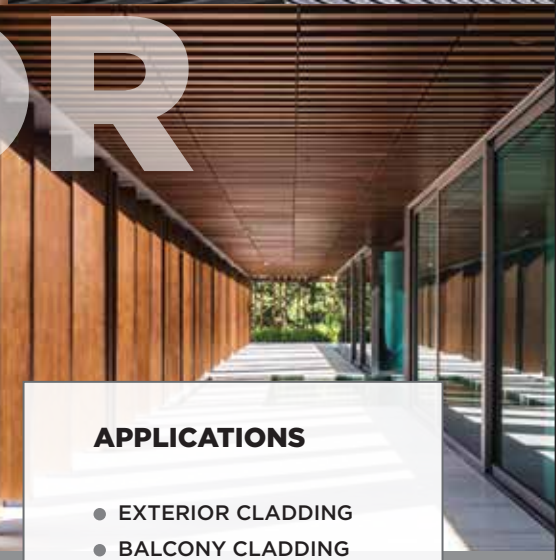
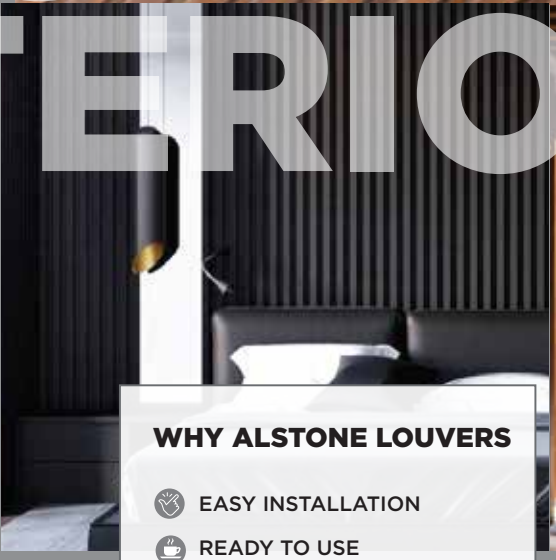

Ⓑ Standard Louvers



EXTERIOR INTERIOR



WHY ALSTONE LOUVERS

-  EASY INSTALLATION
-  READY TO USE
-  WATER & TERMITE PROOF
-  100% MAINTENANCE FREE*
-  WIDE RANGE OF COLOURS
-  IDEAL FOR RESIDENTIAL & COMMERCIAL BUILDINGS

*T&C

APPLICATIONS

- EXTERIOR CLADDING
- BALCONY CLADDING
- ROOF CLADDING
- CANOPY
- GATE PANELING
- FENCE & RAILING
- HIGHLIGHTER

THINK | CLADDING | THINK

ALSTONE[®]

Standard Louvers | Ventilated Fin Louvers



ALSTONE[®]
LOUVERS
LIMITLESS AS YOUR IMAGINATION

ALSTONE VENTILATED FIN LOUVERS

VENTILATED FIN LOUVERS EXCLUSIVE RANGE

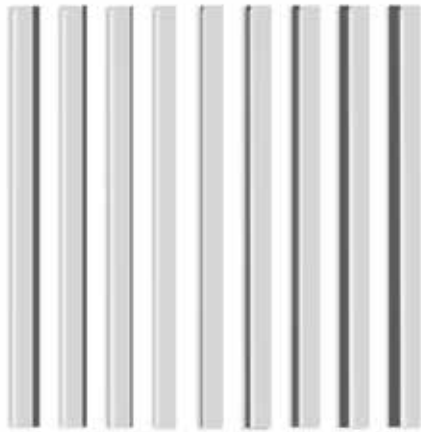

AL-VF-1001 PURE WHITE



AL-VF-1002 COFFEE SILVER

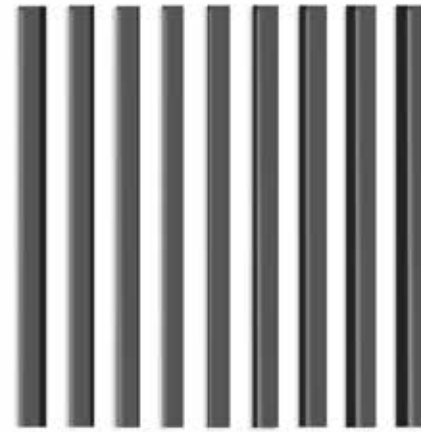

AL-VF-1003 DARK GREY

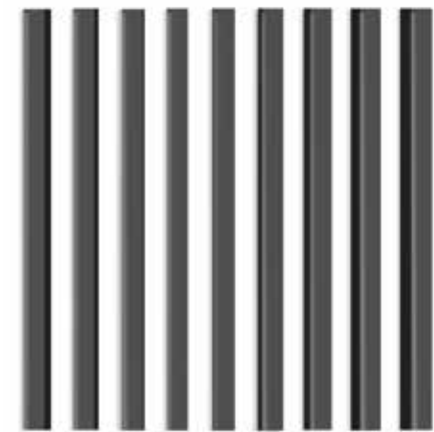

AL-VF-1004 BLACK SILVER



AL-VF-1101 NOVACENTOPINE



AL-VF-1102 DARK TEAK

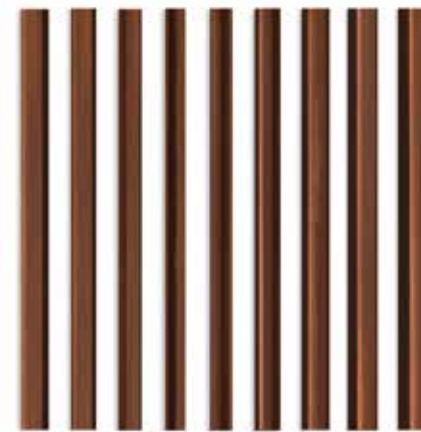

AL-VF-1103 ROYAL TEAK

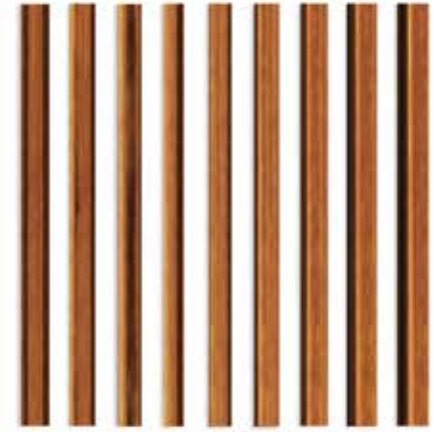

AL-VF-1104 NYANA TEAK

**Shades shown above are for reference only, actual product may vary.*

THINK | CLADDING | THINK
ALSTONE[®]

Standard Louvers | Ventilated Fin Louvers



VENTILATED FIN LOUVERS EXCLUSIVE RANGE



AL-VF-1105

WENGE

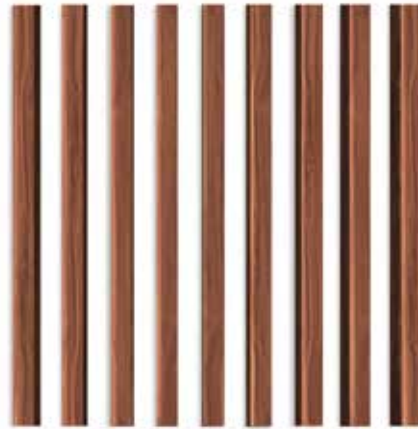

AL-VF-1106

TINEO



AL-VF-1107

TIGER WOOD

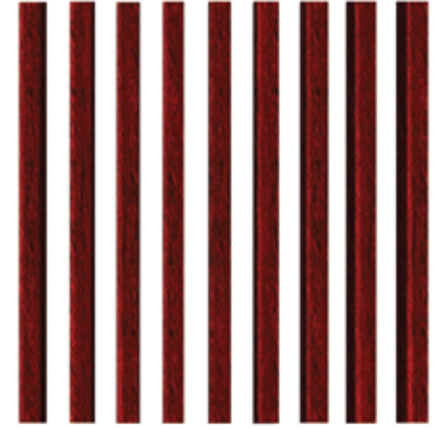

AL-VF-1108

OXFORD CHERRY

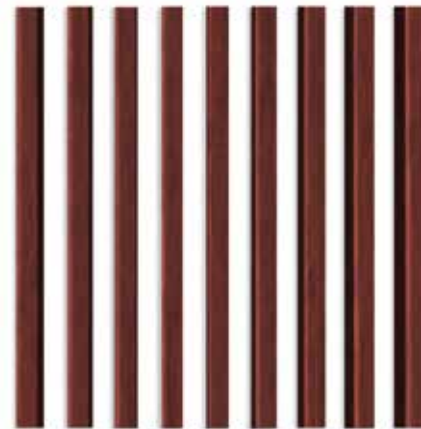

AL-VF-1109

ROSEWOOD



AL-VF-1110

ARMAN Y GREY



AL-VF-1111

SHADOW GREY

**Shades shown above are for reference only, actual product may vary.*

THINK | CLADDING | THINK
ALSTONE[®]

Standard Louvers | Ventilated Fin Louvers



VENTILATED FIN LOUVERS EXCLUSIVE RANGE



AL-VF-6009 VENICE BROWN



AL-VF-6010 ONYX BROWN

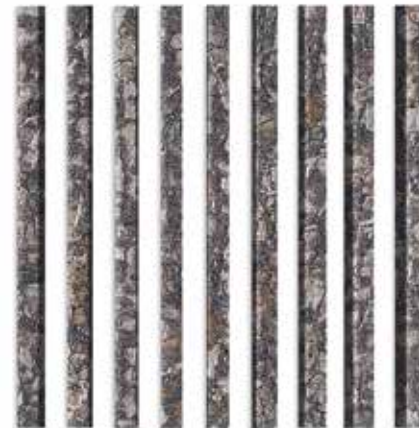

AL-VF-6011 BROWN CASTLE



AL-VF-6012 BLACK CASTLE



AL-VF-9001 CORTEN STEEL



AL-VF-9002 RUSTY COPPER



AL-VF-9003 BRONZE PATINA

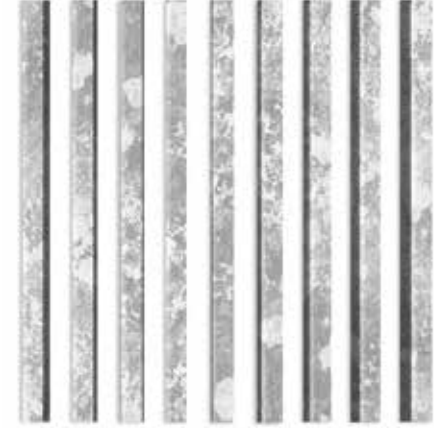

AL-VF-9004 ROUGH BRASS

**Shades shown above are for reference only, actual product may vary.*



VENTILATED FIN LOUVERS EXCLUSIVE RANGE



AL-VF-6001 FOREST ROCK



AL-VF-6002 DECAYED ROCK



AL-VF-6003 DHOLPUR PINK



AL-VF-6004 CEMENT



AL-VF-6005 GRAVEL CEMENT



AL-VF-6006 GREY SPACE



AL-VF-6007 BLACK SPACE

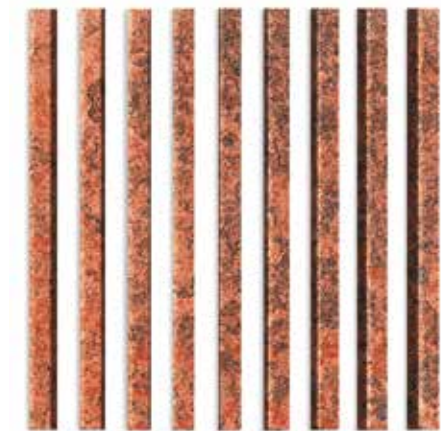

AL-VF-6008 FERRARI RED

**Shades shown above are for reference only, actual product may vary.*

THINK CLADDING THINK
ALSTONE[®]

Standard Louvers | Ventilated Fin Louvers



VENTILATED FIN LOUVERS EXCLUSIVE RANGE



AL-VF-9005 INDUSTRIAL IRON



AL-VF-9006 GILDED RUST



AL-VF-9007 ROUGH CONCRETE



AL-VF-9008 RUSTY GOLD



AL-VF-9009 NECTARINA RUST

**Shades shown above are for reference only, actual product may vary.*

THINK | CLADDING | THINK
ALSTONE[®]

Standard Louvers | Ventilated Fin Louvers



**ALSTONE[®]
LOUVERS**
LIMITLESS AS YOUR IMAGINATION

ALSTONE VENTILATED FIN LOUVERS
2440mm(L) x 38mm(W) x 75mm(H),
Tolerance: ± 5 mm

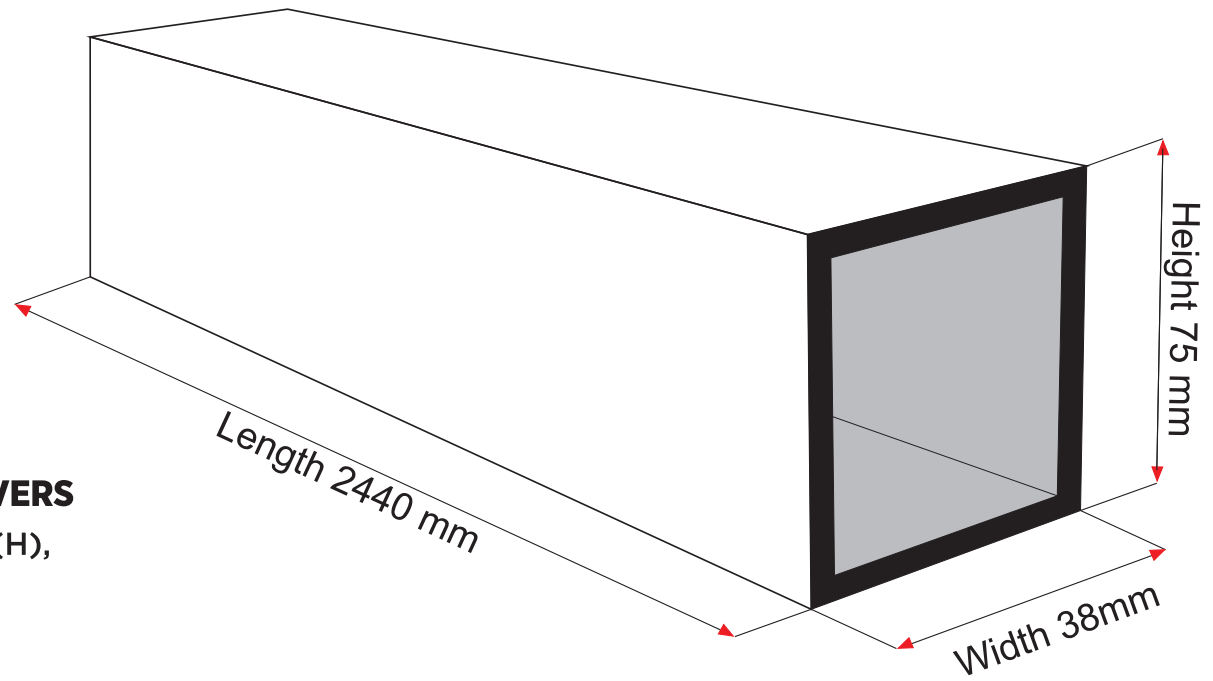

THINK CLADDING THINK

ALSTONE®

Standard Louvers | Ventilated Fin Louvers

**ALSTONE®
LOUVERS**
LIMITLESS AS YOUR IMAGINATION

ALSTONE STANDARD LOUVERS



STANDARD LOUVERS RANGE

ALSTONE[®]
LOWERS
LIMITLESS AS YOUR IMAGINATION



AL-1001 PURE WHITE

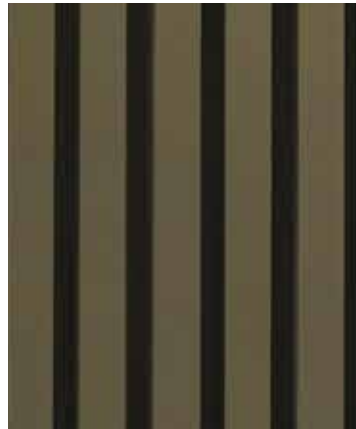

AL-1002 COFFEE SILVER



AL-1003 DARK GREY



AL-1004 BLACK SILVER



AL-1101 NOVACENTOPINE



AL-1102 DARK TEAK



AL-1103 ROYAL TEAK



AL-1104 NYANA TEAK



AL-1105 WENGE



AL-1106 TINEO

**Shades shown above are for reference only, actual product may vary.*

THINK | CLADDING | THINK
ALSTONE®

Standard Louvers | Ventilated Fin Louvers



STANDARD LOUVERS RANGE



AL-1107 TIGER WOOD



AL-1108 OXFORD CHERRY



AL-1109 ROSEWOOD



AL-1110 ARMANI GREY



AL-1111 SHADOW GREY



AL-6001 FOREST ROCK



AL-6002 DECAYED ROCK



AL-6003 DHOLPUR PINK

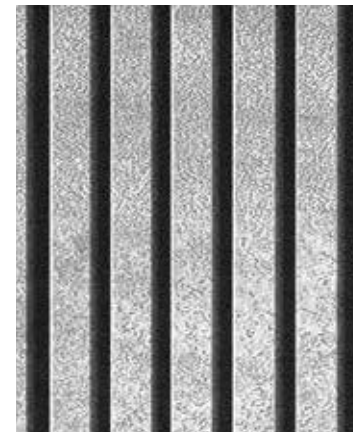

AL-6004 CEMENT



AL-6005 GRAVEL CEMENT

**Shades shown above are for reference only, actual product may vary.*

THINK | CLADDING | THINK
ALSTONE[®]

Standard Louvers | Ventilated Fin Louvers



STANDARD LOUVERS RANGE

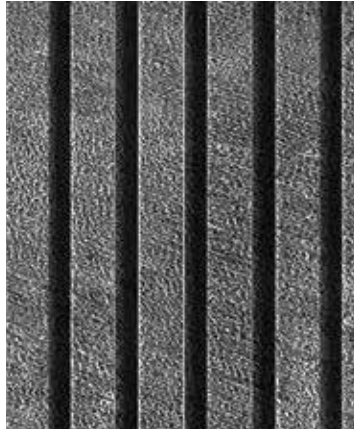

AL-6006 GREY SPACE



AL-6007 BLACK SPACE



AL-6008 FERRARI RED



AL-6009 VENICE BROWN



AL-6010 ONYX BROWN



AL-6011 BROWN CASTLE



AL-6012 BLACK CASTLE

**Shades shown above are for reference only, actual product may vary.*

THINK | CLADDING | THINK
ALSTONE[®]

Standard Louvers | Ventilated Fin Louvers



STANDARD LOUVERS RANGE

ALSTONE[®]
LOUVERS
LIMITLESS AS YOUR IMAGINATION



AL-9001 CORTEN STEEL



AL-9002 RUSTY COPPER



AL-9003 BRONZE PATINA



AL-9004 ROUGH BRASS

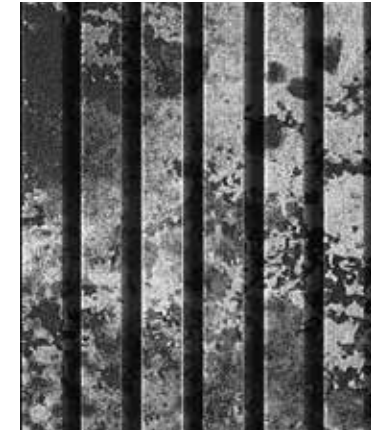

AL-9005 INDUSTRIAL IRON



AL-9006 GILDED RUST



AL-9007 ROUGH CONCRETE



AL-9008 RUSTY GOLD



AL-9009 NECTARINA RUST

**Shades shown above are for reference only, actual product may vary.*

Series: 3200

625mm(W) x 2440mm(H),
Thickness: 30mm
Tolerance: $\pm 10\%$

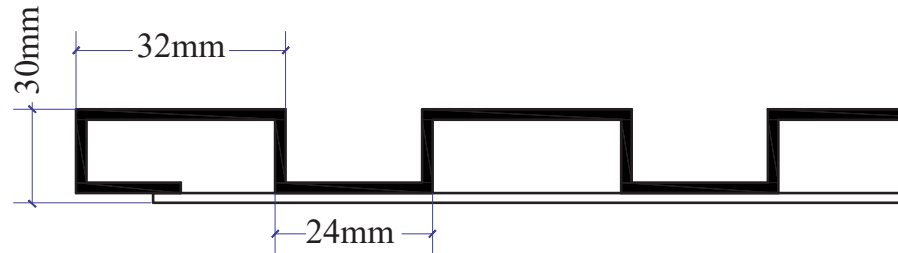

Series: 5500

765mm(W) x 2440mm(H),
Thickness: 30mm
Tolerance: $\pm 10\%$

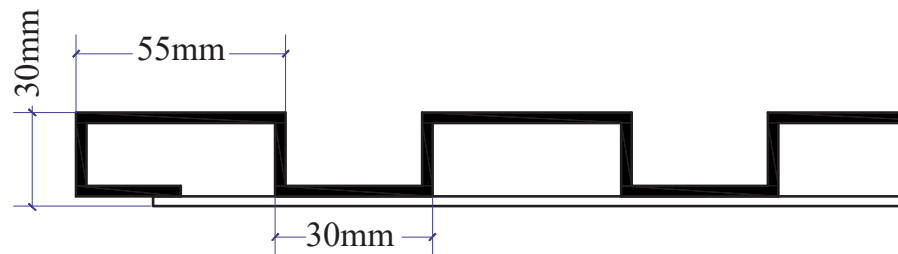

**Customised length is also available (up to 3660mm).*

***Actual colours may vary from the pictures shown in the brochure.*

THINK CLADDING THINK

ALSTONE[®]

OUR PRODUCT RANGE

ALSTONE[®]
ZiNC
IN COLLABORATION WITH **VMZINC**

ALSTONE[®]
ALCOMB
Aluminium Honeycomb Panel

ALSTONE[®]
STONEARC

ALSTONE[®]
HPL
Feel The Nature

ALSTONE[®]
LOUVERS
LIMITLESS AS YOUR IMAGINATION

ALSTONE[®]
ANOMETA
ANODIZED LUXURY

ALSTONE[®]
Stonera
WORK of ART

ALSTONE[®]
ANTIq
BEAUTIFULLY RUSTIC

ALSTONE[®]
3D PANELS

ALSTONE[®]
EVOLUTION
METAL COMPOSITE PANEL

ALSTONE[®]
CLASSIC
METAL COMPOSITE PANEL

ALSTONE[®]
Interio

ALSTONE[®]
SIGN PRO

ALSTONE[®] BEAUTY THAT LASTS LONG
ALSTAR HPL

ALSTONE[®]
ALSTAR
ALUMINIUM COMPOSITE PANEL

Super Batting, Super Cladding! 3.0



ALSTONE MANUFACTURING PVT. LTD.

Corporate Office

15th Floor, Vijaya Building 17, Barakhamba Road,
Connaught Place, New Delhi-110001.

Plant (Uttarakhand)

1393, Langha Road, Industrial Area,
Dehradun, Uttarakhand-248197.

Plant (Rajasthan)

RIICO Industrial Area, Keshwana, District-Kotputli,
Behror (Rajasthan)-303108.

Branches

Ahmedabad | Bengaluru | Bhubneshwar | Chennai |
Delhi | Hyderabad | Indore | Jaipur | Kochi | Kolkata |
Lucknow | Mumbai | Noida | Patna | Pune | Guwahati |
Ranchi

Call: 9599040030

info@alstoneindia.com

www.alstoneindia.com

Follow us @alstonecladding



Scan for
more details

ALSTONE®
Design
Cafe 3D

**CUSTOMISED 3D PREVIEW
OF YOUR PROJECTS**