



Most **compact** mid-wheel chair available on the market



- excellent outdoor performance
- manoeuvrable and compact

SIGMA - midwheeldrive

The SIGMA gives you the freedom to go anywhere you want. It combines all the best features in one electronic wheelchair.

Thanks to the SIGMA's unique suspension and the LiNX steering, driving becomes an amazingly smooth experience and delivers an excellent performance in outdoor usage.

Even when fully equipped, the SIGMA remains compact and highly manoeuvrable. Perfect for negotiating sharp turns in tight situations as well as in open spaces.

The SIGMA wheelchair is available in different configurations and is built to measure. We strive to give you the best possible experience and the ultimate seating and driving comfort. A wide range of options allows the SIGMA to be adjusted to your personal needs and lifestyle.

■ unique suspension

■ driving comfort

SIGMA - VERMEIREN design

Our professional designers developed a unique suspension system with 3 pendulum arms. As such, all 6 wheels are in constant contact with the ground.. on all sorts of terrains.

Because of this unique 3-points suspension, the SIGMA ensures stability at any given time and can handle height differences up to 50 mm (65 mm for the SIGMA 230).

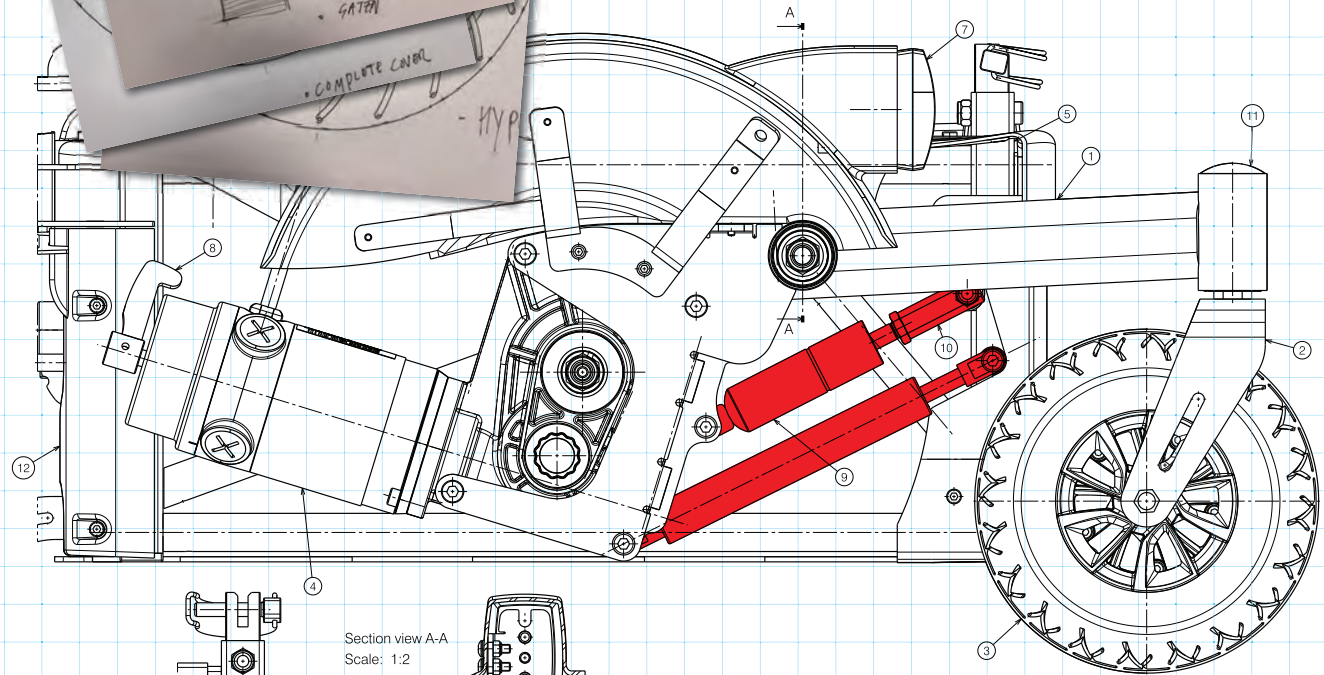
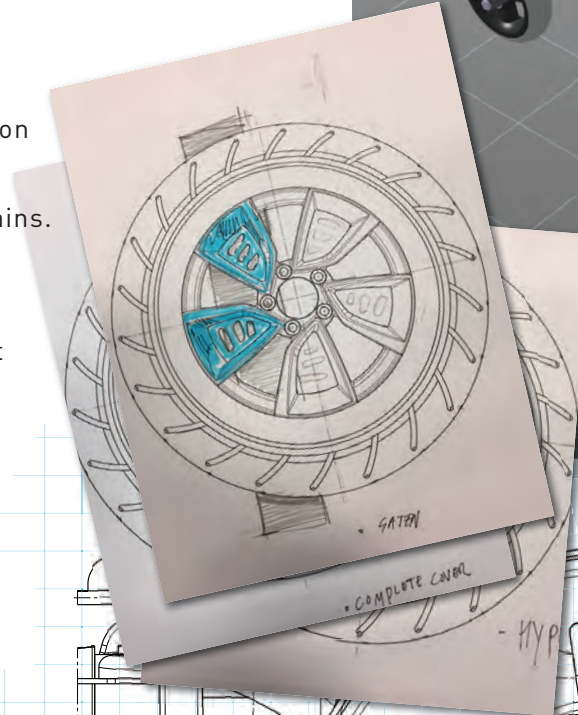
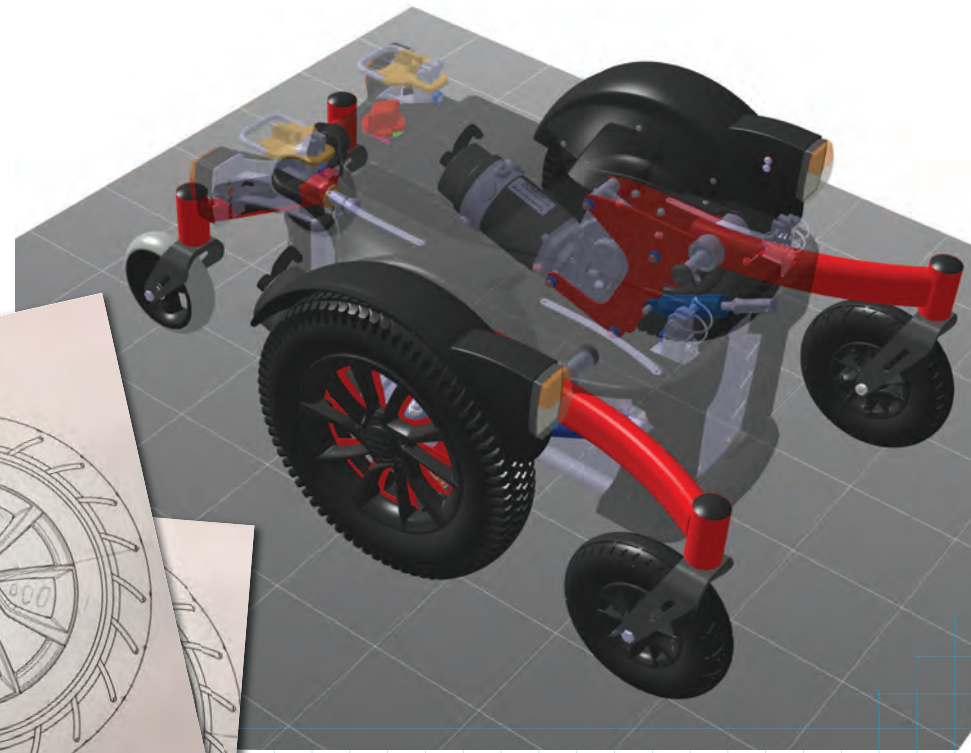



The next generation wheelchair control system

- A seamless and expandable system
- Modular components – mix and match modules
- State-of-the-art technology
- Revolutionary approach to programming



■ adaptive controllers

SIGMA - LiNX controllers

The SIGMA comes with a **LiNX** controller system.

LiNX is an adaptive steering which constantly adjusts itself towards the driving conditions. It will detect when the SIGMA is driving on two different undergrounds (for example grass and concrete) and will compensate by adding extra power to one side as to keep the balance of power even and keep the SIGMA going in a straight line.

Due to its modular construction, the **LiNX** controller can easily be upgraded by adding options, adjust some of its functions and conduct maintenance.

One of the most used controllers is the basic controller, a standard controller with access to most of the SIGMA's features.



SE08 - Extra controller



SE09 - Attendant controller



SE64 - 10-way switch

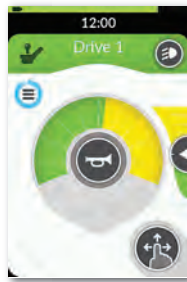

LiNX controller with LCD touch screen
 Allows access to a large number of functions (inclination of seat and backrest, lighting ...) with direct visualization on the LCD screen for more comfort and practicality.



The **LiNX** interface is available on iOS and PC, allowing you to configure a chair or analyse its data quickly and easily.

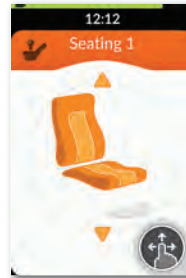

Seat adjustments

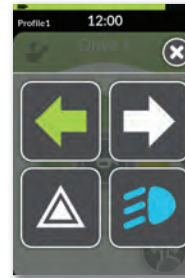

Visible and clear icons

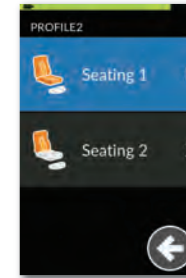

Personalised seating

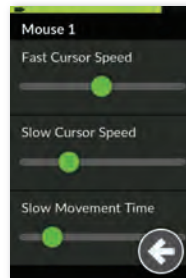

Fine-tuning of the settings

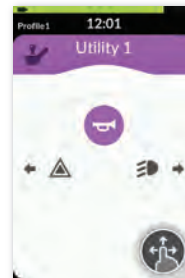

Different utility programs

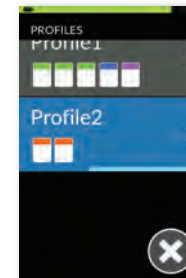

Personalised profiles

LiNX offers comprehensive data and statistics to monitor the performance of your wheelchair. They can be viewed in real time with a Bluetooth® connection.

The dongle key can be used to adjust any chair equipped with a **LiNX** controller.



SE83 - Mini joystick



SE82 - Button controller

SIGMA - LiNX additional controllers

Additional controllers consist out of a separate screen, an extra controller that can be mounted at the back, 10-way switch for fingertip control and a number of special adaptive controllers to find the most ideal solution for each user.



■ freedom of movement

SIGMA - controllers

VERMEIREN strives to enhance the personal comfort of each users and offers different types of controllers and systems depending on the personal needs of each person. From basic controllers to made to measure chin controllers with fully integrated touchscreens.

SE04 - Chin controller



SE63 - Softball for joystick



SE02 - LiNX basic controller



SE02 - LiNX LCD controller



SE53 - Swing away controller



SE53A - Swing away controller with lock positions



SE53Z - Swing away down controller



SE55 - Reinforced controller

personal comfort

SIGMA - Seating comfort

Comfortable backrests are essential to any persons daily comfort. From soft, preshaped backrests to backrests with special ventilation pores or the more stylish, artificial leather ones.. all types are compatible with the SIGMA wheelchair and will add to a more pleasant experience when driving it.



Armrest in PU material



Armrest in artificial leather



Armrest in soft material



Back and seat in perspiration ventilating material



Backrest and seat in SOFT material



Backrest and seat in artificial leather

■ seating configurations

Optional seating configurations are available upon request. From an optional lift (SE42) to bridge a gap up to 300 mm or additional seat tilting up to 50° (SE43). These extra functions add to the quality of your lifestyle and can make things easier.



■ trendy design



■ SIGMA 230

Design does not always mean you have to give in when it comes to functionality. For the users that demand a little extra, we have created the SIGMA 230. Equipped with bigger front wheels, steel front forks and an additional obstacle height up to 65mm.



■ conformity

SIGMA - Your guarantee of quality

Regarding quality, the SIGMA complies with the highest norms, laid down by certified test institutes in most European countries.

The wheelchair must be adapted to you, not vice versa

Our basic principle is: the wheelchair must be adapted to you, not vice versa. This is why our wheelchairs have a modular design.

All types of wheelchairs can be adapted, have numerous accessories and all options are mutually interchangeable. This is the result of our continuous research and more than 62 years of experience



options

B06 - manual legrests

BZ8 ART - manual comfort legrests

BZ8E ART - electrical comfort legrests

B15A - table in ABS material

B31 - crutch holder

L04 - side support

SE24 - cup holder

SE26 - push bar

BZ10E - electrical footplate

L55 - adjustable headrest

L58 - adjustable comfort headrest

L44 - tension adjustable backrest

B58 - safety belt with AUTO lock

SE16 - plexiglass side plate

SE27 - topcase

SE74 - side mirror

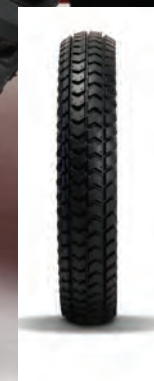
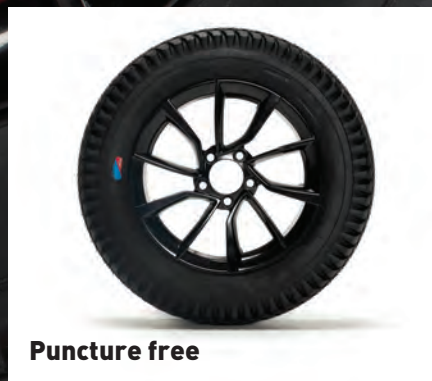
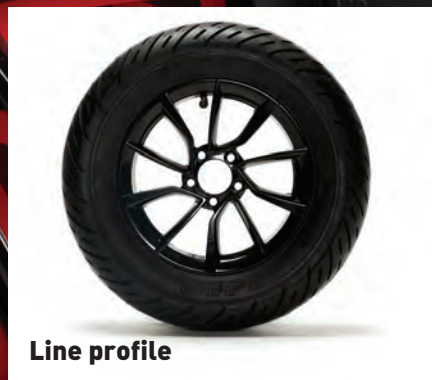
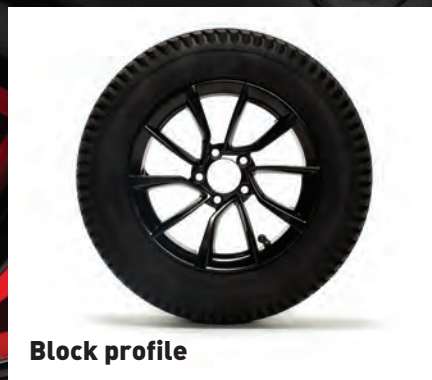



B06



BZ8 ART



BZ8E ART



B15A



B31



L04



SE24



SE26



BZ10E



L55



L58



L44



B58



SE16



SE27



SE74



SIGMA - matte and glossy colours

SIGMA is available in a wide range of different and vibrant colours to match your personal style. Either go for a subtle matte colour or a more striking glossy colour. Your colour of choice is represented in all the details of the SIGMA including the inner side of the central wheel rim and the lower front side of the battery encasing.

matte colours

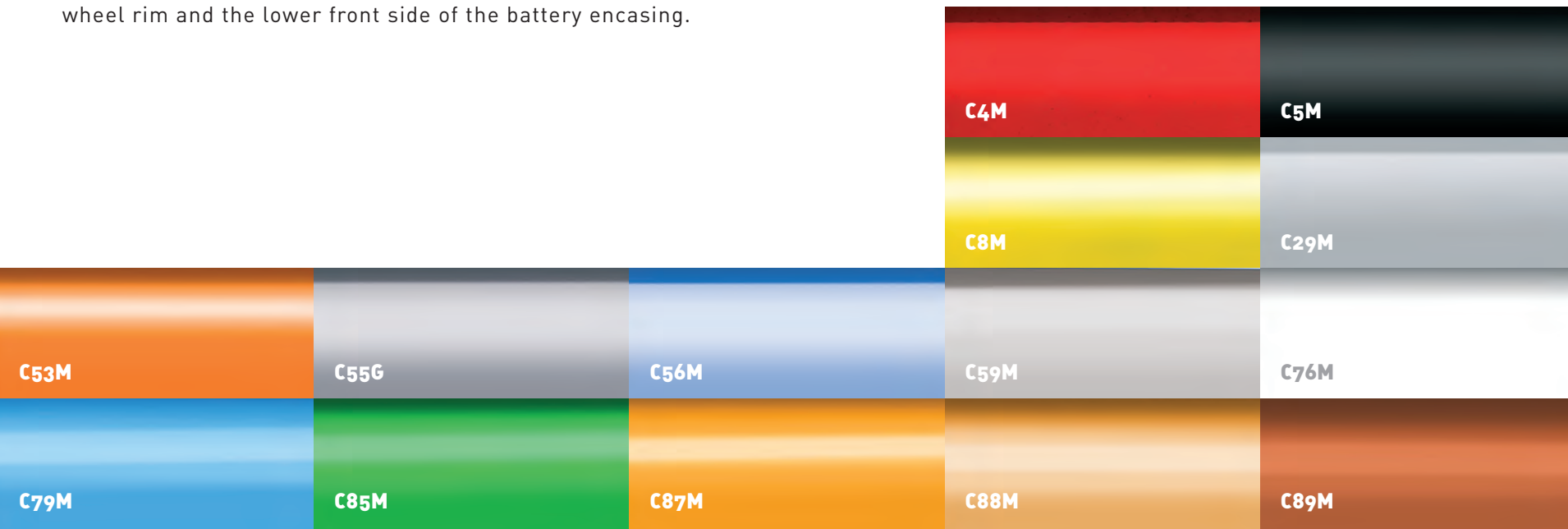

■ dimensions

Length, width, height...how much does it weigh? Do I need a bigger or a smaller seat width?... All these are important questions that we answer in our technical manuals to provide everyone with accurate information that will help you to make the right decisions on which model to get.

Max. weight of user	150 kg			
rolstoel class	B			
Overall length with leg rest	1177 mm	1163 mm	1198 mm	
Overall width	580 mm - 630 mm - 680 mm			
Total mass	141 kg	154 kg	168 kg	
Mass of the heaviest part	133.75 kg	146.75 kg	160.75 kg	
Masses of removable parts				
Footrest B06	1,95 kg (per piece)			
Backrest	3.35 kg			
Charger	0,95 kg			
Static stability downhill	6°			
Static stability uphill	6°			
Static stability sideways	6°			
Energy consumption *	35 km			
Dynamic stability uphill	6°			
Obstacle climbing	50 mm - (SIGMA 230 : 65 mm) - (run-up of 0.5m)			
Maximum speed forward	6 km/h 10 km/h			
Minimum braking distance from max. speed	2.1 m			
Seat plane angle	21° (manual)	0 - 20° (electric)	0° - 50° (electric)	0° - 45° (electric)
Effective seat depth	420-440-460-480-500-520 mm			

Effective seat width	400 mm - 450 mm - 500 mm			
Seat surface height at front edge (adjustable for SE30, SE34, SE36, SE39, SE40, SE41)	435-450-465-480-495 mm			
Seat surface height at front edge (adjustable for type SE42+SE40, SE42+SE39)	478 to 538 mm			
Seat surface height at front edge (adjustable for type E43)	453 to 513 mm			
Backrest angle	32° (manual)	0 - 37° (electric)	0° - 37° (electric)	0° - 37° (electric)
Backrest height	610 mm			
Footrest to seat distance (BZ10E)	365 – 465 mm			
Leg to seat surface angle	90° - 153°			
Armrest to seat distance	250 – 530 mm			
Minimum turning radius	1200 mm			
Ground clearance (bottom base frame)	65 mm			
Diameter mid wheels	350 x70 mm			
Type of mid wheels	3.00-8, air tyre			
Diameter front wheels	200 x 50 mm - (SIGMA 230 : 230 x 50 mm)			
Type of front wheels	Rubber tyre			
Diameter balance wheels	140 x 40 mm			
Type of balance wheels	Rubber tyre			
Base frame with wheels - dimensions	962x618x377 mm - SIGMA 230: 962x672x377 mm			
Standard model, parts	<ul style="list-style-type: none"> • Arm pad in PU, Foldable, Quick release • Footrest B06 • Backrest L34 • Swing-away controller • Taxi hooks (6x) • Mudguards • Safety belt 			
Description electrical parts				
Battery (Non-spillable AGM battery) Capacity: Output:	80,0Ah/20hr 12V DC			
Driving motors	2 x 220W with EM brake		2 x 350W with EM brake	



2x12V-80Ah	2x220W 2x350W	6 km/h 10 km/h	35 km	6°	50 65 (SIGMA 230)	1200				
580 630 680	400 450 500	manual 32° electrical 37°	435 450 465 480 495	420 440 460 480 500 520	610	365-465	1177	>141	150	kg

Measurements in mm, weight in kg - Deviations in sizes and weight (1,5 cm and 1,5 kg) are possible.

- unique suspension
- driving comfort
- excellent outdoor performance
- manoeuvrable and compact
- extensive product range

distributed by

