

Year of  
Establishment  
**2016**

**Manufacturer,  
Exporter & Supplier**

Rothe Packtech Pvt. Ltd., your premier destination for innovative packaging solutions designed to streamline your industrial operations. Founded in 2016 by Mr. Ravindra Rothe, we are a Pune, Maharashtra-based company dedicated to manufacturing, exporting, and supplying a wide range of high-quality packaging machinery, including industrial palletizers, case packers, standard conveyor systems, turnkey conveyor systems, and case erectors.

At Rothe Packtech Pvt. Ltd., we understand the importance of efficient and reliable packaging processes in today's competitive market. That's why we specialize in providing cutting-edge solutions that enhance productivity, minimize downtime, and optimize efficiency across various industries.

Our industrial palletizers are designed to automate the palletizing process, allowing for fast and precise stacking of products onto pallets. Whether you're handling bags, boxes, or containers, our palletizers can accommodate a wide range of product types and sizes, ensuring consistency and accuracy in palletization.

For case packing needs, our range of case packers offers versatility and reliability. From top-loading to side-loading configurations, our case packers are capable of efficiently packing products into cases with precision and speed, reducing manual labor and increasing throughput.

To facilitate smooth material handling and product transportation, we offer both standard conveyor systems and turnkey conveyor systems tailored to your specific requirements. Our conveyor systems are designed to seamlessly integrate with your existing production line, providing efficient product flow and minimizing bottlenecks.

Additionally, our case erectors are engineered to automatically form and seal corrugated cases, eliminating the need for manual case erection and improving overall packaging efficiency.

#### **Name of Founder**

**Mr. Ravindra Rothe**

#### **Year of Establishment**

**2016**

#### **Nature of Business**

**Manufacturer, Exporter & Supplier**

#### **Market Covered**

**Worldwide**



**Gantry Palletizer**

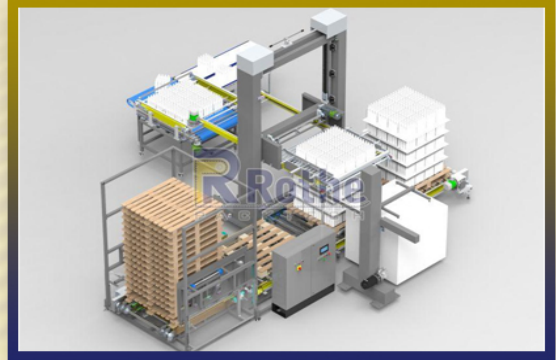

**Low Level Palletizer**



**Low Speed Palletizer**



**Robotic Palletizer**

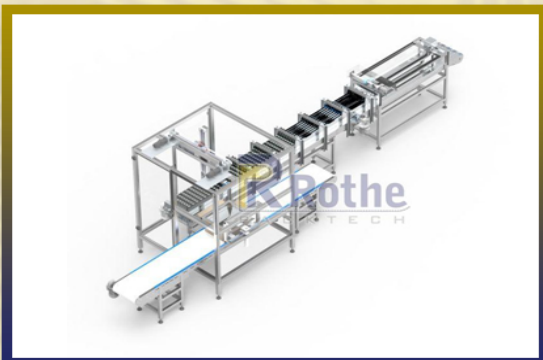

**Bottle Case Packer**



**Drop Case Packer**



**Gantry Case Packer**



**Robotic Case Packer**



**ARB Conveyor System**



**Chain Conveyor System**



**Flat Belt Conveyor System**

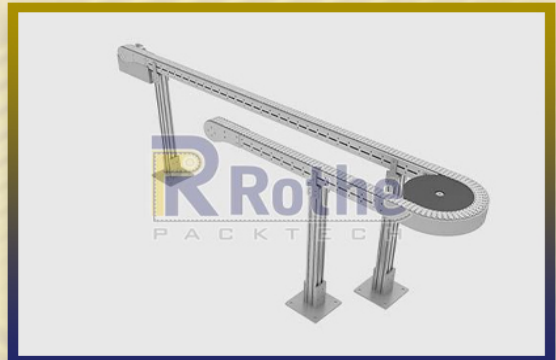

**Flexi Link Conveyor System**



**Gravity Roller Conveyor System**



**Knife Edge Conveyor System**



**Modular Conveyor System**



**Pallet Roller Conveyor System**

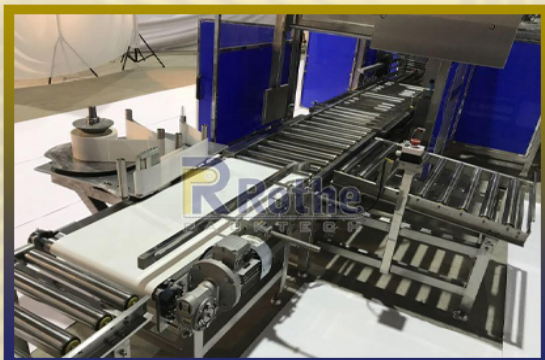

**Power Roller Conveyor System**

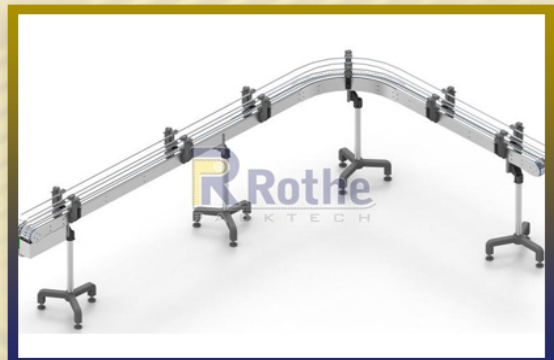

**Slat Chain Conveyor System**

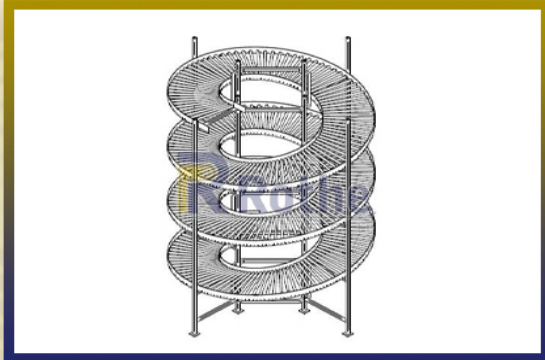

**Spiral Conveyor System**



**Take Up Conveyor System**

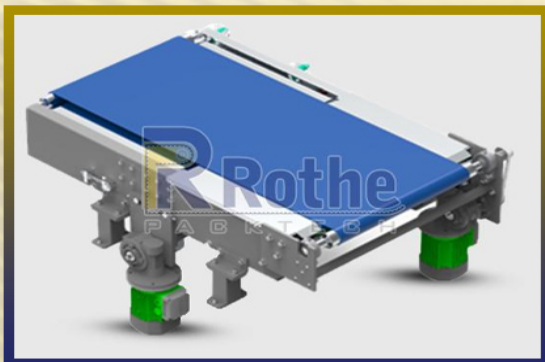

**Telescopic Conveyor System**



**Through Belt Conveyor System**



**Vertical Lifter Conveyor System**



**Weighing Conveyor System**



**Z Type Conveyor System**



**Cross Transfer Conveyor System**



**DWS Conveyor System**



**Floor To Floor Transfer  
Conveyor System**



**Lane Diverter Conveyor System**



**Case Erector**

 **Mr. Ravindra Rothe**  
Mob. No.- +91-9822267494

 **Ms. Ashwini Ade**  
Mob. No.- +91-9096662970

 **Mr. Yogesh Pokle**  
Mob. No.- +91-8956297401

 **Address**  
Gat No. 191, Behind Jyotiba Temple, Talawade,  
Pune, Maharashtra - 412114, India

 **Call Us**  
08048784802

 **Email**  
sales@rothe.in as primary mail id

 **Alternate Email ID**  
ravi@rothe.in, yogesh@rothe.in

 **Web Page**  
[www.exportersindia.com/rothe-packtech-pvt-ltd](http://www.exportersindia.com/rothe-packtech-pvt-ltd)

