

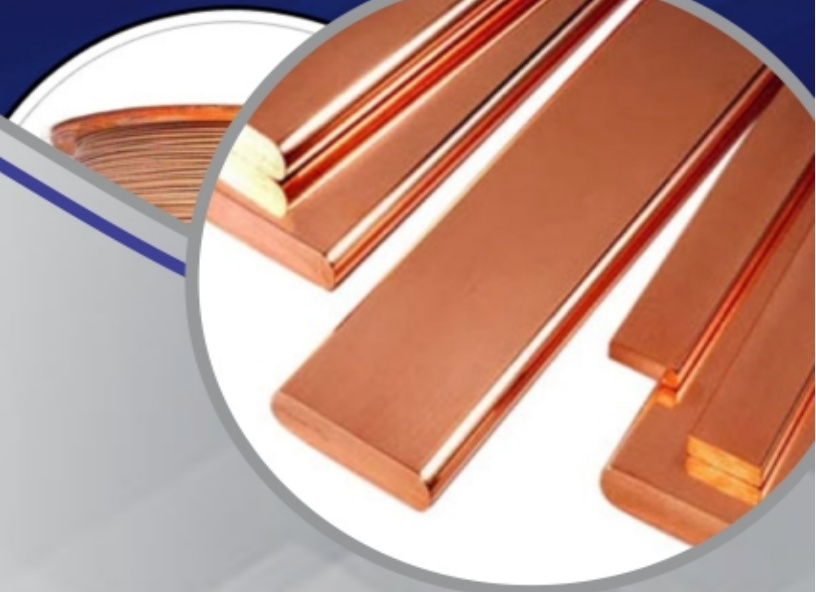

# VM INSULATION

VIDYA METAL MANUFACTURING CO. PVT. LTD.  
WINDING WIRES

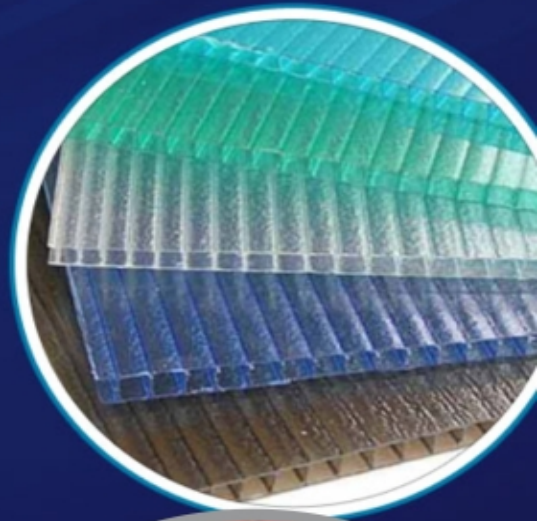
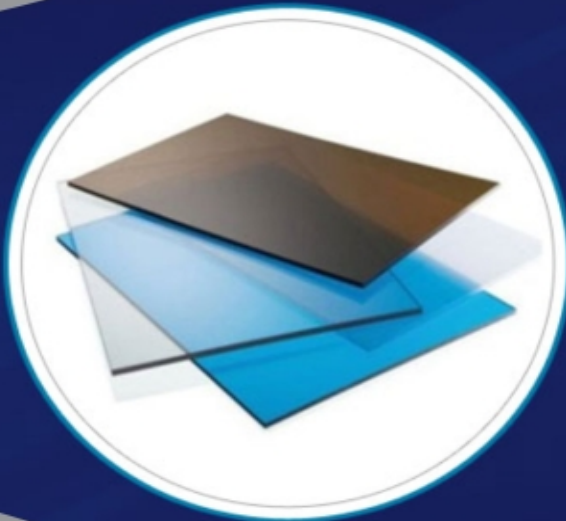
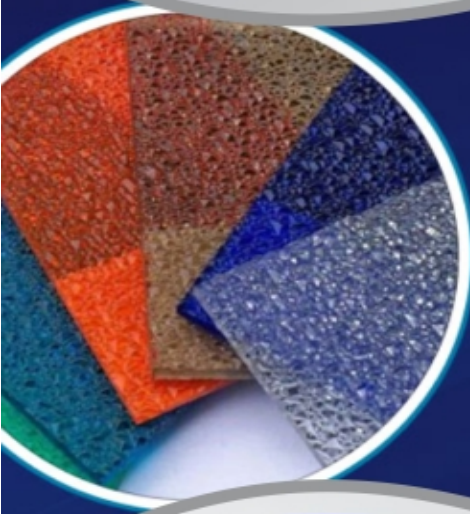

Vidya Metal Manufacturing Company Private Limited, the flagship company of the VMI Group, is the technology leader and is one of the largest manufacturers of Super Enamelled Aluminium Winding Wire & Strips for both industrial and automotive applications in the Indian Electronic Industry.

# About Us

Vidya Metal Manufacturing Company Private Limited, the flagship company of the VMI Group, is the technology leader and is one of the largest manufacturers of Super Enamelled Aluminium Winding Wire & Strips for both industrial and automotive applications in the Indian Electronic Industry.

In India, Vidya Metal is the preferred supplier to major Inverter & Battery Manufacturers (OEM's & Replacement), Transformer Manufacturers, Indian Railways and to major PSU.

For our accomplishment story, we are grateful to our founder Mr. R.S. Tawar, whose continual backing and direction have been useful to us for attaining exponential development in the current market.

## Our Team

Supported by a highly capable team of professionals, we have been able to provide a durable range of products in various specifications. Our team comprises procuring agents, quality controllers, storekeepers and sales & marketing representatives, who strive hard to provide maximum satisfaction to clients.

## Supreme Quality Material

- Sourcing Aluminium and Copper from India's Largest Suppliers - Hindalco, Vedanta and others.
- Imported Best Class Enamel from Elantas or Dr Beck.

## Advanced Machinery & Technology

- Enamelling on imported machines.
- Inline pinhole testing.
- Inline wire outer diameter testing.
- Concentricity Measurement

## Personalized/Custom-made Solutions

- Availability of all grades and sizes as per the customer requirement.
- Internal R&D team.
- Product Upgradation.

## International Quality Management System

- ISO 9001:2015 & ISO 14001:2015 certified.
- All of the products are UL approved.
- RoHS compliant products.
- Eco-friendly.

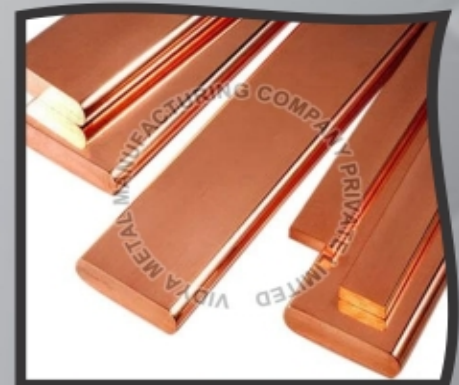

# Our Products

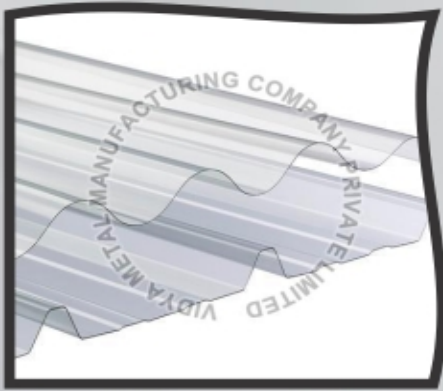

C-130 Extruded Profile Sheet

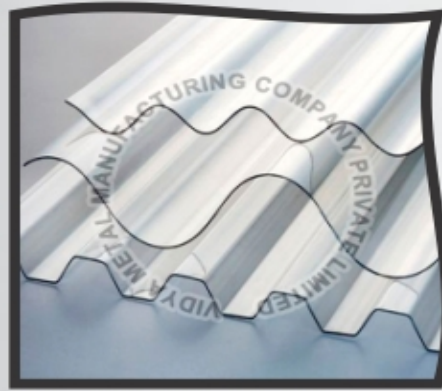

C-76 Extruded Profile Sheet

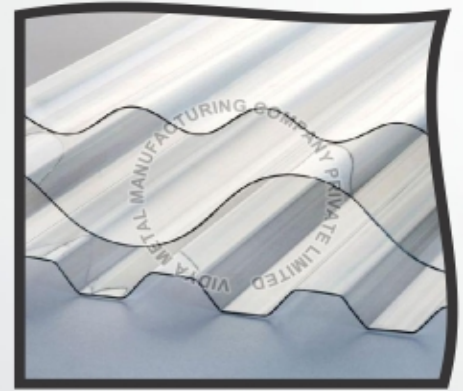

Corrugated Polycarbonate Sheet

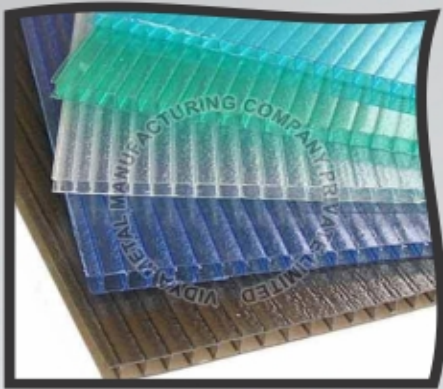

Multiwall Polycarbonate Sheet

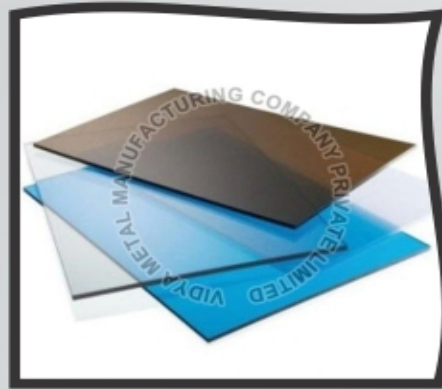

Polycarbonate Compact Sheet



Polycarbonate Diamond Sheet

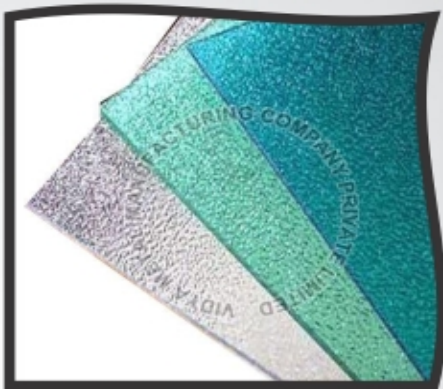

Polycarbonate Embossed Sheet

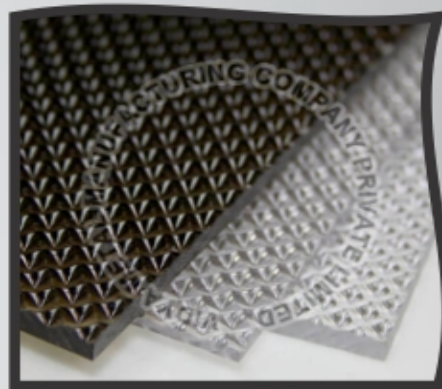

Prismatic Polycarbonate Sheet



Solid Polycarbonate Sheet

# Our Products



U-45 Extruded  
Profile Sheet



Copper Hexagonal  
Rod



Copper Round  
Rod



Copper Square Rod



Aluminium Fiberglass  
Winding Wire



Enamelled Rectangular  
Winding Wire



Enamelled Round  
Winding Wire



Paper Insulated Rectangular  
Copper Conductor



Paper Insulated Round  
Copper Conductor

# Our Products

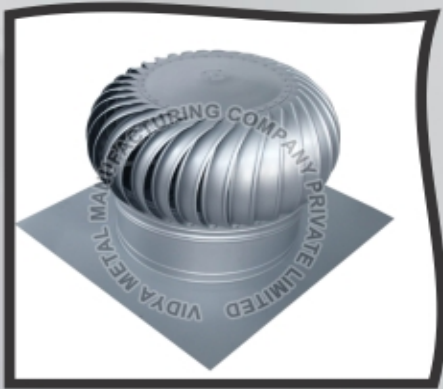

Turbine Air Ventilator



Polycarbonate Ventilator Base Plate

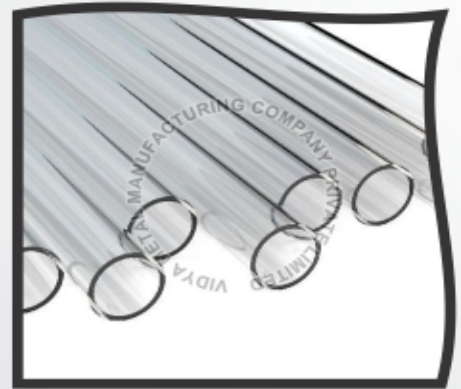

Polycarbonate Tube



Polycarbonate Shield



Polycarbonate Baton Stick



Multicell Polycarbonate Panel

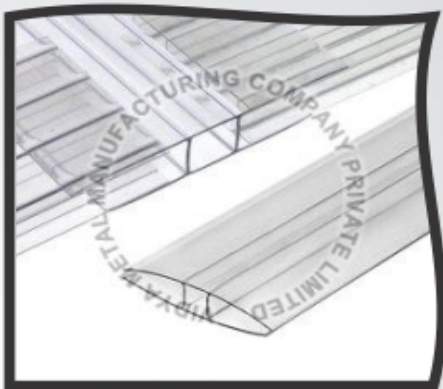

Polycarbonate Connector

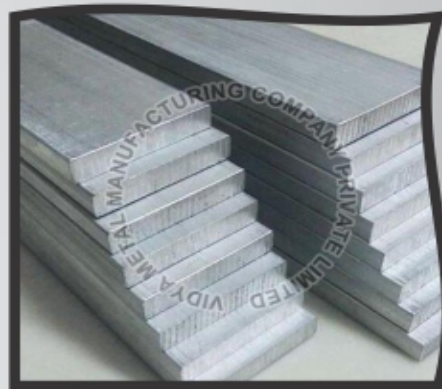

Aluminum Bus Bar



Paper Covered Aluminium Strip

# Our Products



Paper Covered Copper Strip



Welding Wire Spools



Pin Hole Tester



Tan Delta Tester



Cut Through Tester



Hot Air Oven

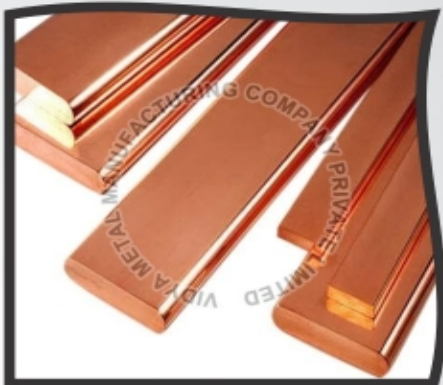

Copper Flat Bar

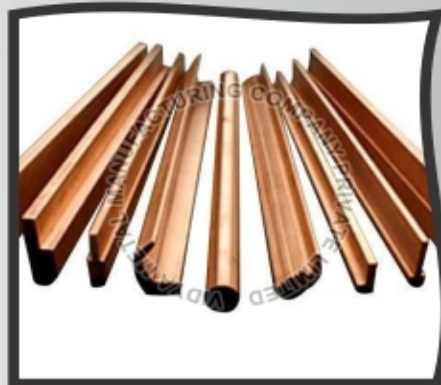

Copper Profiles



Copper Wire



**Mr. R.S. Tawar**

SP-812/F39-40, Riico Industrial Area, Bhiwadi, Rajasthan, India - 301019

**Call Us :** +91-9350186072, 8048779679

**Email :** ram.singh@vmigroup.org

**Web Address :** www.vidyametal.co.in

**Web Page :** www.exportersindia.com/vmi-group-of-industries



Yazaki India  
याज़ाकि इंडिया

PHASE-1  
फेस-1

JMV HYUNDAI  
BHIWADI

ELAM CHOWK  
नीलम चौक

919

Hill Top Rd

Dhaba Comp  
डाबा प

SECTOR - 3  
सेक्टर - 3

Savour Indi

TOR 3  
फ्टर 3

Orient Cables  
ओरिएंट केबल्स

PHASE  
फेस II

R.T.O Office

Harchandpur  
हरचंदपुर

Capital Mall  
केपिटल मॉल

Relaxo Footwears  
Ltd unit3  
रिलैक्सो  
फुटवियर्स...

Eugia Pharma  
Specialities Limited

SECTOR 10  
सेक्टर 10

Santhalka  
संथाल्का

BKT Ty  
बीकेटी

PHASE-LLL  
फेस-थ्री

R 9  
9

HARIJAN BASTI  
हरिजन  
बस्ती

Bhiwadi Cylinder  
भिवाड़ी सिलेंडर

CTOR 24  
सेक्टर 24

KK Rd  
Gemscab  
Industries Limited  
जीईएमएससीएबी  
इंडस्ट्रीज...

Cool cool SwimmingPool  
कूल कूल  
स्विमिंगपूल

Pardhan Dha