

# Linear Drainage System

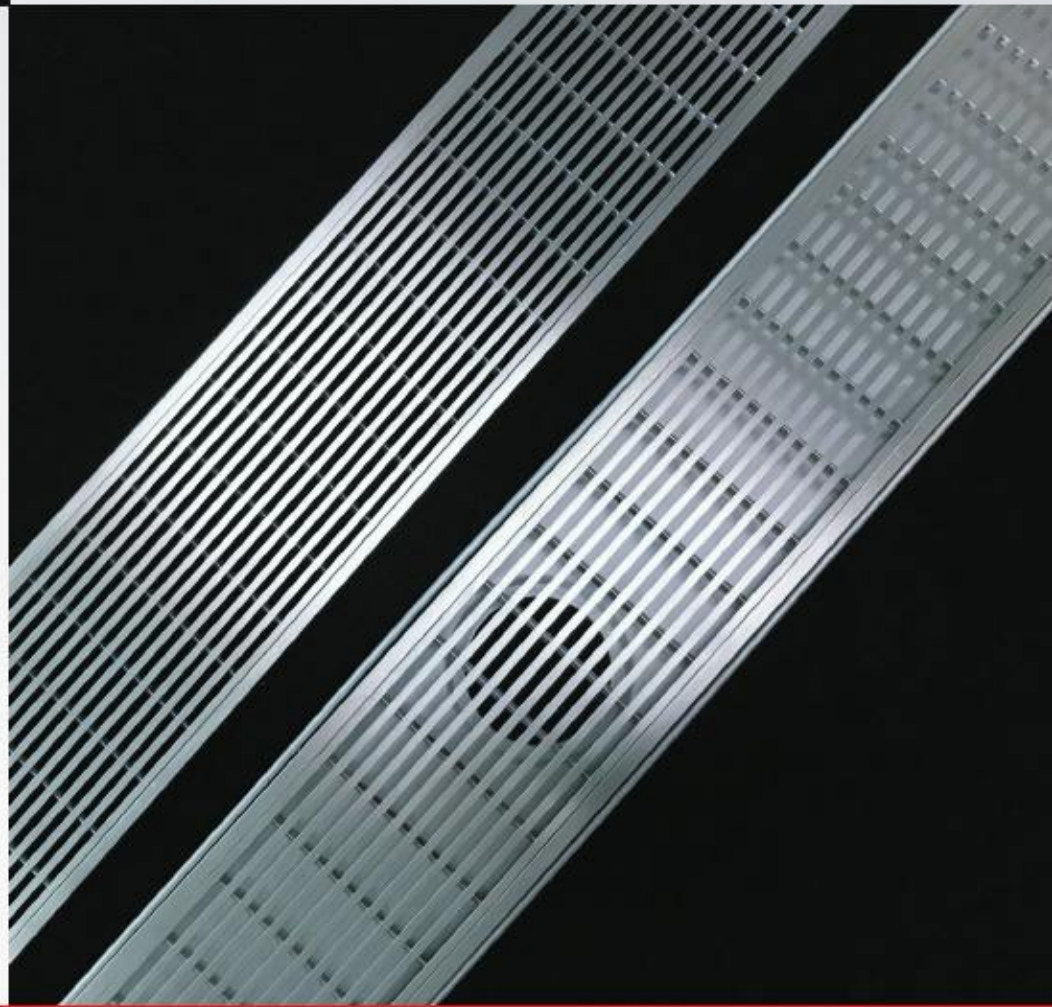

**Professional Manufacturer**

## **Wedge Wire Grate**



**VISIT US AT**

[www.aljawini.net](http://www.aljawini.net)

[www.aljawiniest.net](http://www.aljawiniest.net)



**VISIT US AT**  
[www.aljawini.net](http://www.aljawini.net)  
[www.aljawiniest.net](http://www.aljawiniest.net)

## Introduction

Century Woven is the professional wedge wire grates manufacturer in China. It has more than 30 years history, with head office located in Beijing, the capital of China.

In 2008, We make technology innovation in linear grate, research and develop new production technology and introduce advanced equipments, which greatly improve the quality of products.

The decorative stainless steel linear grates are used in bathroom showers, swimming pool surrounds, balconies, driveways, storm drainage, threshold, public walkways, protecting tree roots, etc.

We can cater for your project requirement with various finishes, such as No.4 finish, satin polished (brushed), mirror polished, Anti-slip finish.

Our linear drain grates products get favor and approval from most customers in different countries, also get the WATER MARK certification from Australia.

We are committed to providing reliable, high-quality products and service for global buyers with accumulated rich experience in the production and export of wedge wire grates products. Our products have been exported to USA, Canada, Germany, Australia, New Zealand, Saudi Arabia, Dubai and other dozens of worldwide countries, across five continents with hundreds of customers. We always uphold integrity, high quality, innovation and win-win business philosophy, constantly explore the international market, and strive to create value for customers and employees.







## Contents

Introduction.....	1
Contents.....	2
Product Features.....	3-4
Linear Drain Grate.....	5-6
Linear Shower Drain .....	7-8
Pool Drainage System.....	9-12
Outdoor Drainage System....	13-14





VISIT US AT

[www.aljawini.net](http://www.aljawini.net)

[www.aljawiniest.net](http://www.aljawiniest.net)

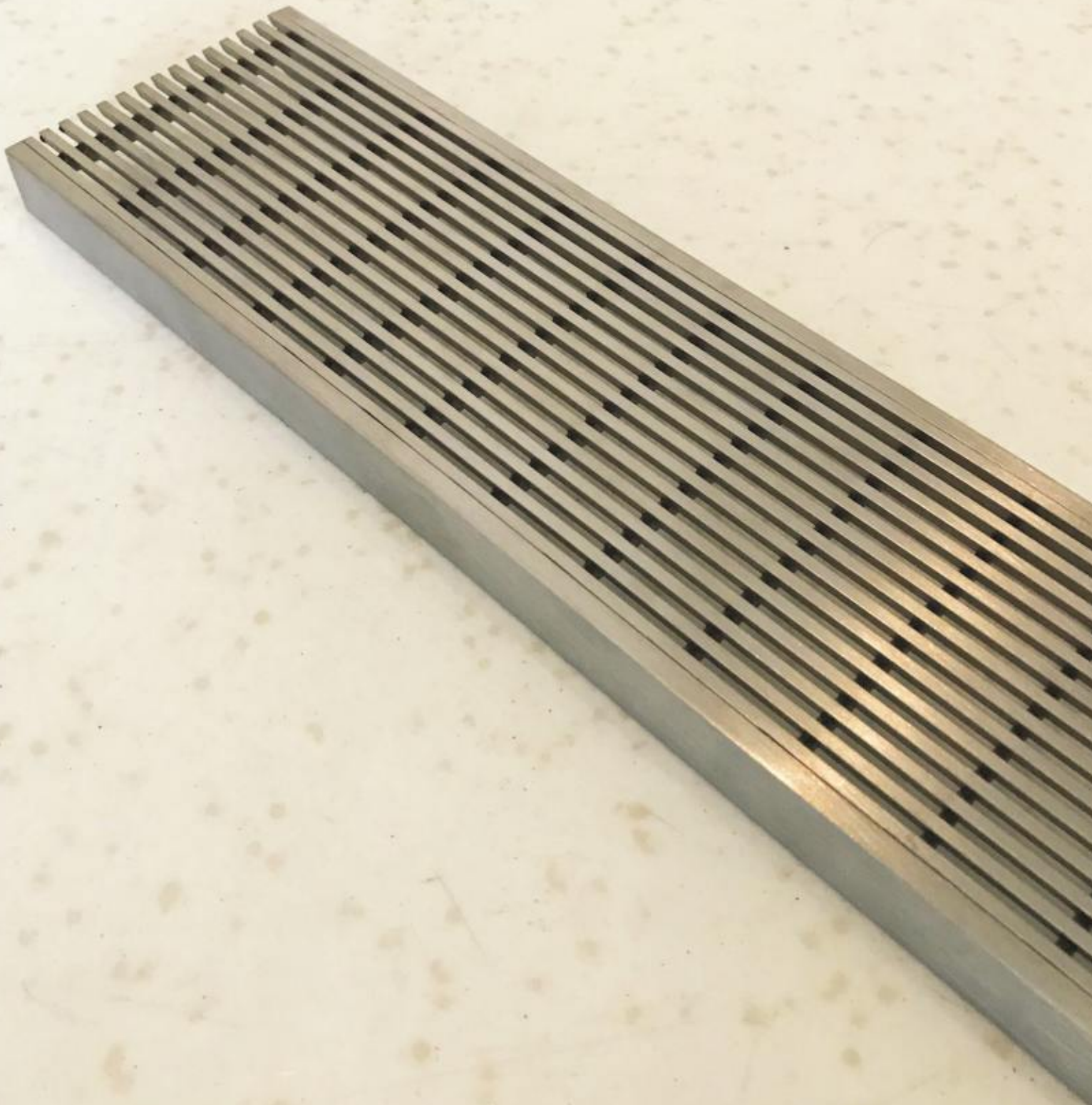



VISIT US AT  
[www.aljawini.net](http://www.aljawini.net)  
[www.aljawiniest.net](http://www.aljawiniest.net)

## Product Features

- The linear floor grating meets an essential need for buildings; it removes water and waste build up in areas with high traffic. They are functionally important, but they also need to be safe for use, aesthetically pleasing, and highly durable .
- Our wedge wire grate drain are manufactured using the marine grade materials, so you can enjoy your grates for many years, no matter how you choose to utilise them. If you need a grate for your pool or spa area, then rest assured that our products will be able to withstand the harsh chemicals used in pools. And our grates had the water mark certificate from Australia.
- All our linear drain grate system designs are customizable, and we can offer different width(40mm–1200mm) and length(Max 3.5Meters), so we can adapt to your particular project and its needs.
- Our Linear grates can be used for a variety of applications, including:
  - Public walkways
  - Threshold
  - Bathroom drainage
  - Driveway grates
  - Shopping centres
  - Pool surrounds
  - Balconies
  - Tree grates

# Linear Drain Grate

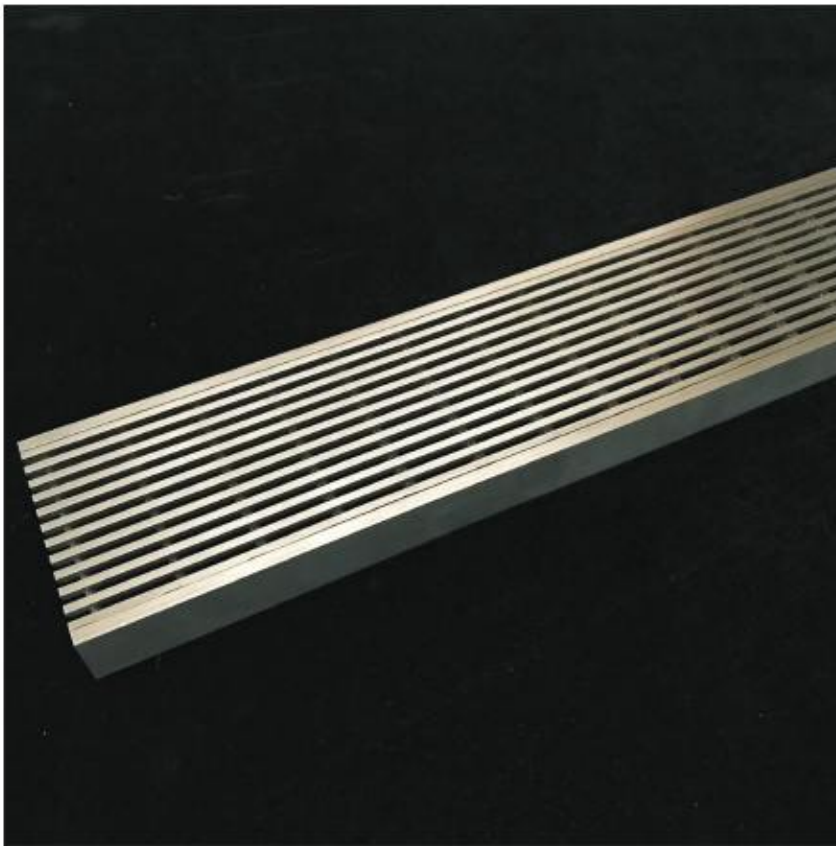

Material: Marine Grade  
 Stainless steel 316L  
 Width: 40mm-1200mm  
 Length: Max 3500mm  
 Surface Treatment: No.4 finish,  
 satin polished (brushed), mirror  
 polished, Anti-slip finish.  
 Other sizes can be customized

Profile Wire			
3W	5W	5W anti-slip	

Gap/Slot: From 2mm to 14mm or Customized

Support Bar				
6H	12H	15H	20H	

Side Bar				
3x15mm	3x20mm	5x20mm	5x30mm	





VISIT US AT  
[www.aljawini.net](http://www.aljawini.net)  
[www.aljawniest.net](http://www.aljawniest.net)

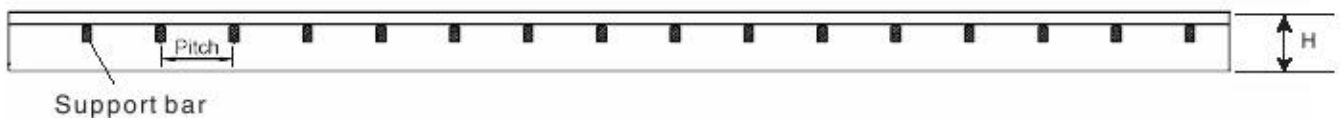
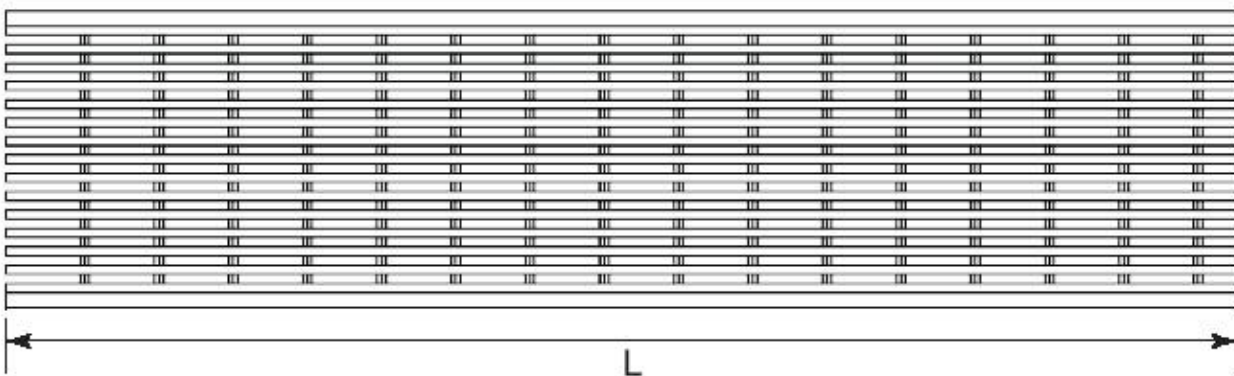
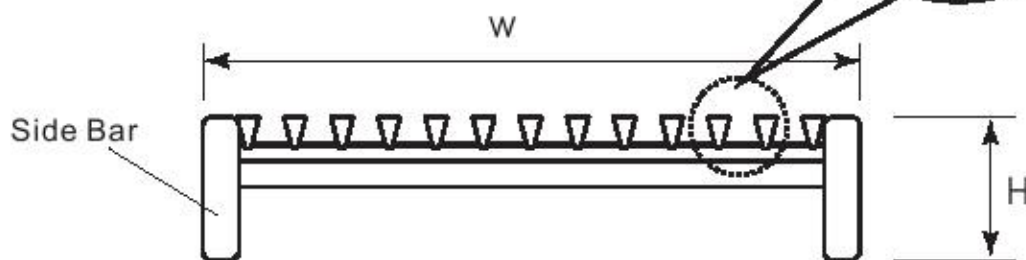
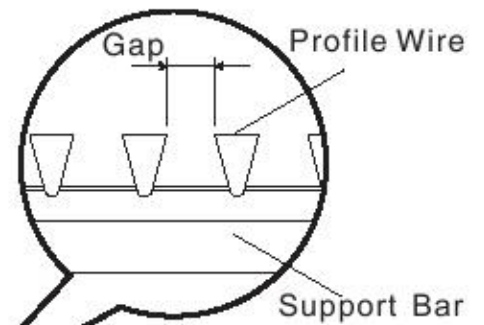
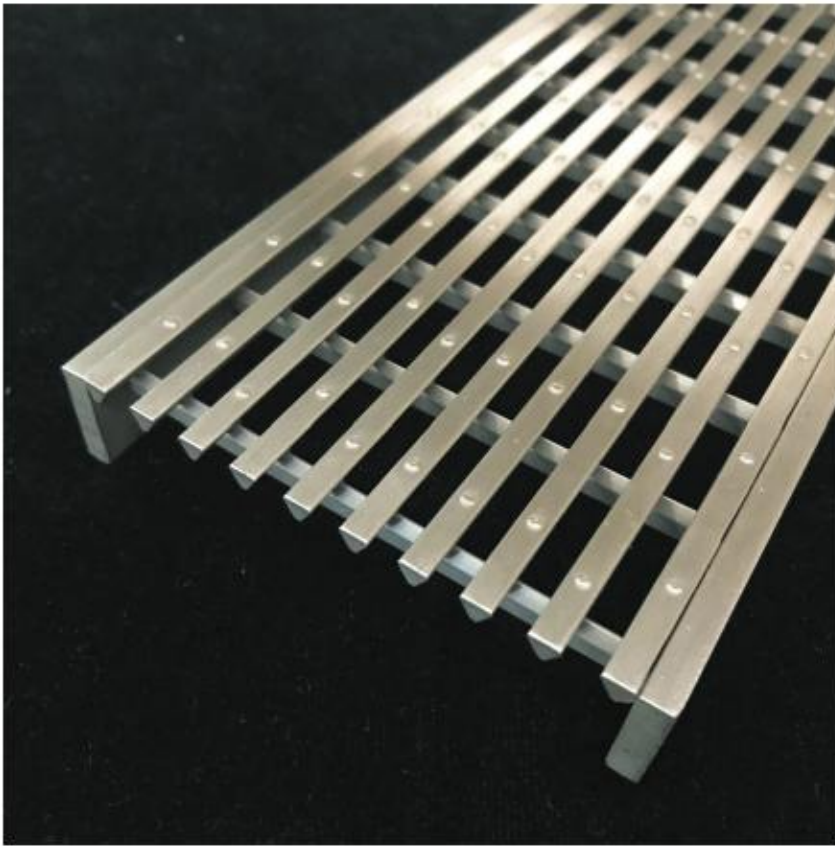

# Linear Shower Drain



Our shower grates are manufactured using high quality 316L grade stainless steel and are available in various designs and linear lengths , the wedge wire grates meet your wet area.

We sell custom shower grates in any length, width and shape, and we can supply the metal mesh attached the grates together, each one is suit your custom drain and grate requirements. For the larger bathroom with dual walk in style showers, you can be sure our grates will comfortably handle the water flow multiple shower heads produce.

Our shower grates channel standard range consists of:

Width	Length	Height	Outlet
85mm	600/800/900/ 1000/1200/1500mm	22mm	40mm and 50mm
100mm			
Other sizes can be customized			





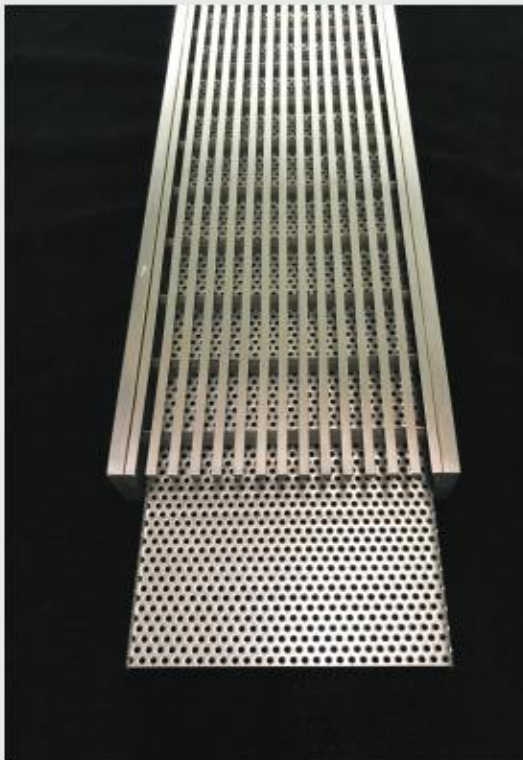
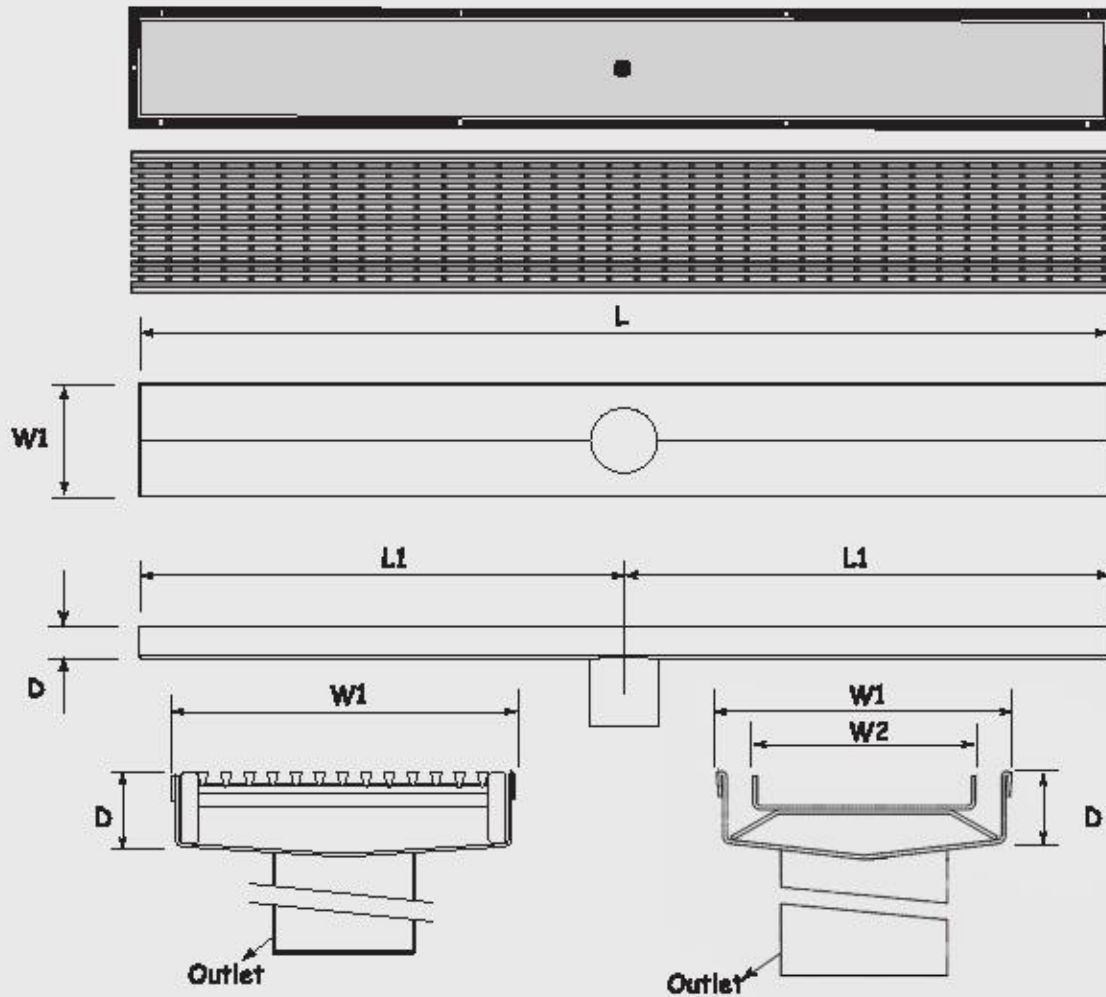

# Pool Drainage System





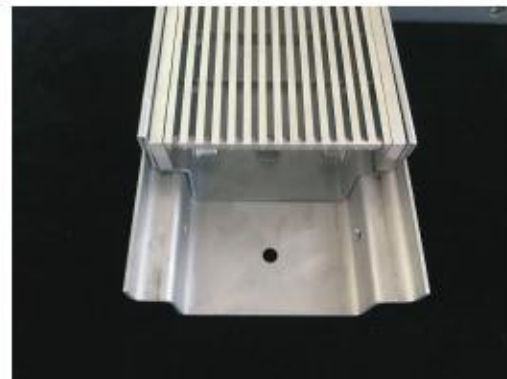
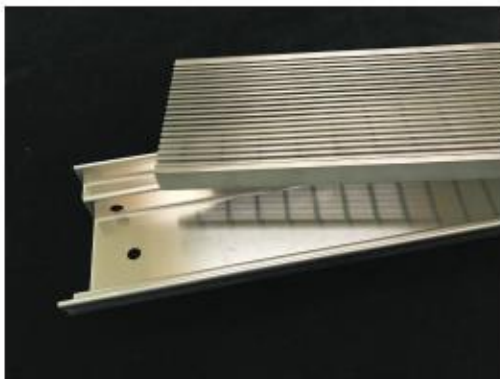
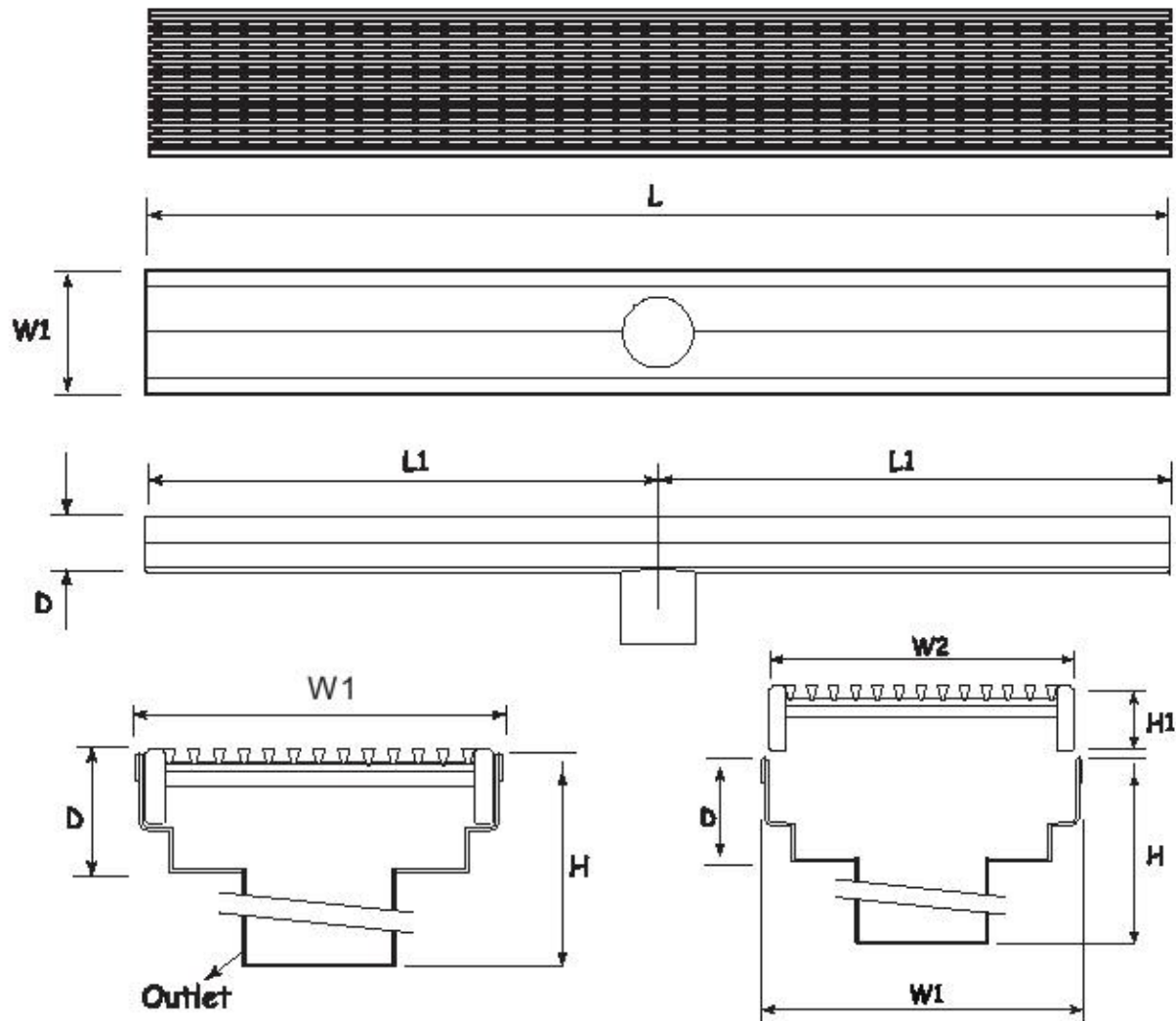

# Pool Drainage System







VISIT US AT  
[www.aljawini.net](http://www.aljawini.net)  
[www.aljawiniest.net](http://www.aljawiniest.net)

Our drainage solutions are manufactured using marine grade materials, so you can enjoy your grates for many years, no matter how you choose to utilise them. If you need a grate for your pool or spa area, then rest assured that our products will not rust.



Stainless steel wedge wire grate is lightweight, making the drain grate easy to remove, and the cleaning simple. Leaves and debris are easily flushed away so that you can enjoy a clean environment. Every aspect of our pool drain grate have been carefully engineered to offer maximum effectiveness, no matter what type of location you use it in.

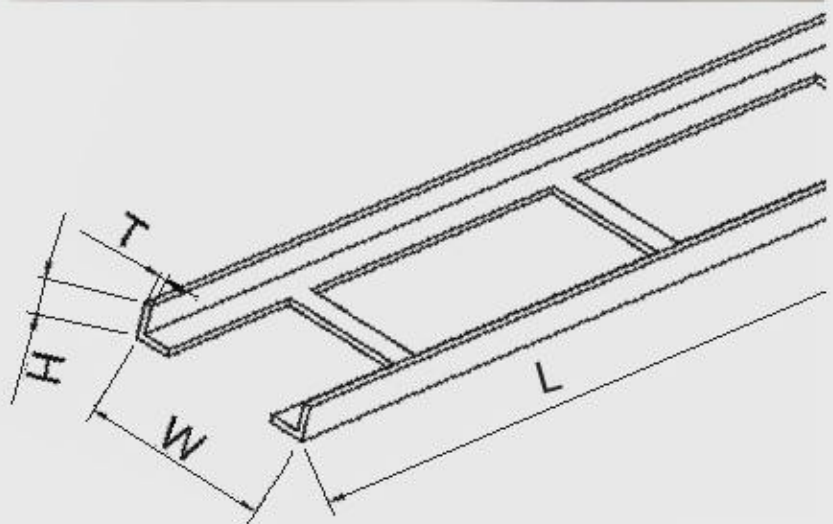



# Outdoor Drainage System

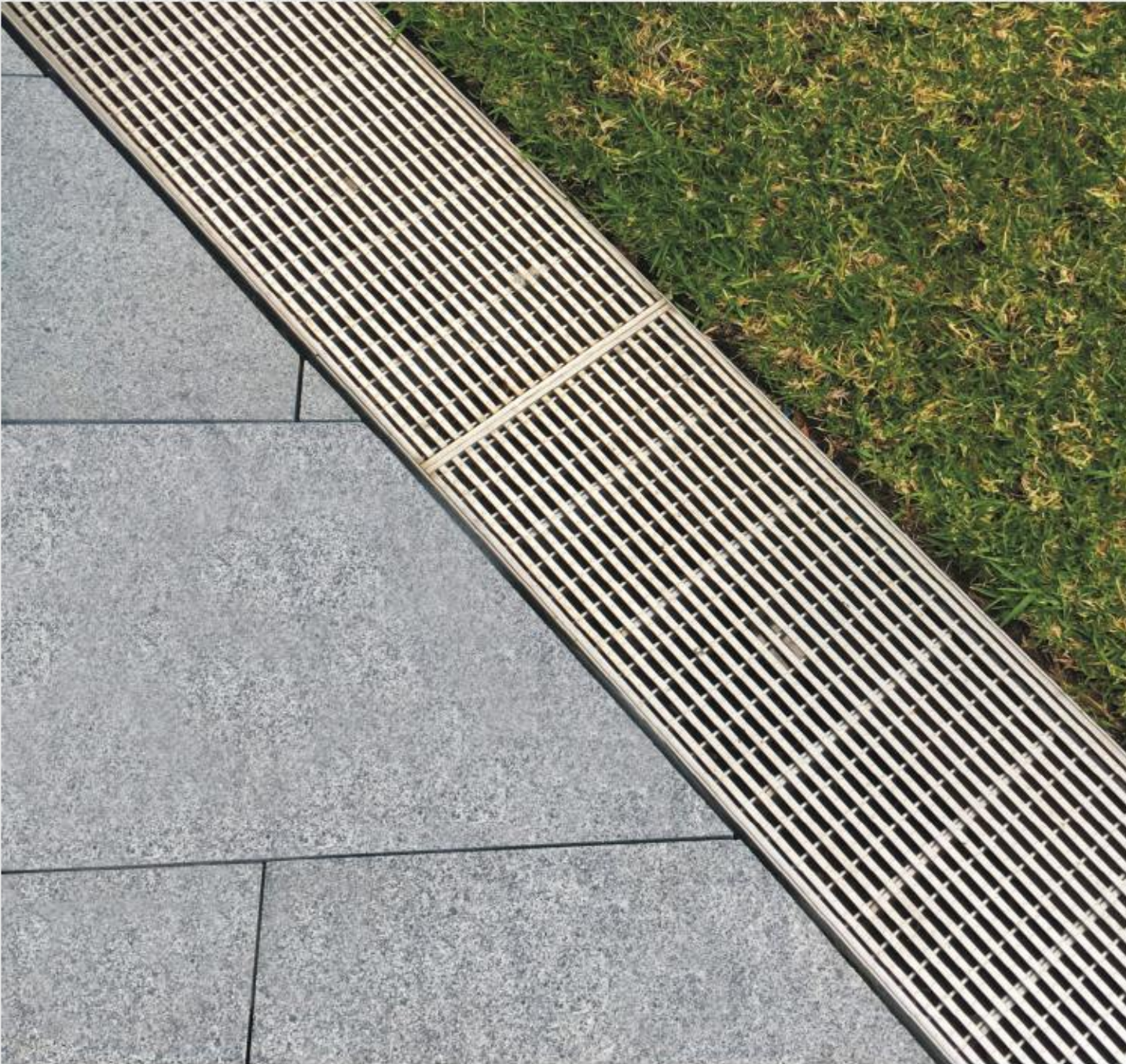





VISIT US AT  
[www.aljawini.net](http://www.aljawini.net)  
[www.aljawiniest.net](http://www.aljawiniest.net)

