



L.B. ORTHO SURGICAL

**GENERAL SURGERY
INSTRUMENTS - CATALOGUE**

L.B. ORTHO SURGICAL
NEW DELHI, INDIA



L.B. ORTHO SURGICAL



**METZENBAUM SCISSORS
STRAIGHT
5", 6", 7", 8", 9", 10"**



**METZENBAUM SCISSORS
CURVED
5", 6", 7", 8", 9", 10"**



**METZENBAUM SCISSORS
CURVED
6", 7", 8"**



**METZENBAUM SCISSORS
STRAIGHT
6", 7", 8"**



**METZENBAUM SCISSORS
CURVED
6", 7"**



**METZENBAUM SCISSORS
STRAIGHT
6", 7"**



**MAYO SCISSORS
CURVED**
5½", 6½", 7½", 8½", 9½", 10½"



**MAYO SCISSORS
CURVED**
5½", 6½", 7½", 8½"



**MAYO SCISSORS
CURVED**
6½", 7½"



**MAYO SCISSORS
STRAIGHT**
5½", 6½", 7½", 8½", 9½", 10½"



**MAYO SCISSORS
STRAIGHT**
5½", 6½", 7½", 8½"



**MAYO SCISSORS
STRAIGHT**
6½", 7½"



5", 6"



DRESSING SCISSORS
STRAIGHT (SHARP x SHARP)



5", 6"



5", 6"



DRESSING SCISSORS
STRAIGHT (SHARP x BLUNT)



5", 6"



GAUGE
CUTTING SCISSORS



UMBILICAL CORD
SCISSORS 5"



Heath Suture
REMOVAL SCISSORS



Lister Bandage
SCISSORS 5½", 7½"



EPISIOTOMY
SCISSORS



STEVENS SCISSORS
STRAIGHT

4 1/2"



STEVENS SCISSORS
STRAIGHT

4 1/2", 5 1/2"



STEVENS SCISSORS
STRAIGHT

4 1/2", 5 1/2"



GREEN BERG SCISSORS
STRAIGHT

5 1/2"



GREEN BERG SCISSORS
STRAIGHT

5 1/2", 6 1/2"



GREEN BERG SCISSORS
STRAIGHT

5 1/2", 6 1/2"



KNAPP SCISSORS
STRAIGHT
4½"



KNAPP SCISSORS
CURVED
4½"



KNAPP SCISSORS
STRAIGHT
4½", 5½"



KNAPP SCISSORS
CURVED
4", 5"



KNAPP SCISSORS
STRAIGHT
4½", 5½"



KNAPP SCISSORS
CURVED
4", 5"



IRIS SCISSORS
STRAIGHT
3½", 4", 5"



IRIS SCISSORS
CURVED
3½", 4", 5"



IRIS SCISSORS
STRAIGHT
3½", 4", 5"



IRIS SCISSORS
CURVED
3½", 4", 5"



IRIS SCISSORS
STRAIGHT
4", 5"



IRIS SCISSORS
CURVED
3½", 4", 5"

Yasargil micro scissors
Bayonet shape



L.B. ORTHO SURGICAL



YASARGIL

22.5cm/9"
24.5cm/9¾"
22.5cm/9"



CASTROVIEJO SCISSORS



VANNAS SCISSORS



WESTCOTT CURVED TENOTOMY SCISSORS



MICRO SPRING NEEDLE HOLDER FLAT HANDLE
6", 7", 8"



MICRO SPRITNITGA NNIUEMEDLE
HOLDER ROUND HANDLE
6", 7", 8"



YASARGIL



FINE MICRO SPRING NEEDLE HOLDER FLAT HANDLEE



Barraquer Needle Holder Fine Tip



Barraquer Needle Holder Fine



YASARGIL



Yasargil micro needle holder bayonet shape



ARTERY FORCEPS
5", 6", 7", 8", 9", 10"



KELLY
ARTERY FORCEPS
6", 8"



KOCHER'S
ARTERY FORCEPS
6", 8", 10"



4", 5", 6",
MOSQUITO FORCEPS
STAINLESS STEEL



MOSQUITO FORCEPS
TITANIUM



6", 8"
LANES TISSUE
FORCEPS

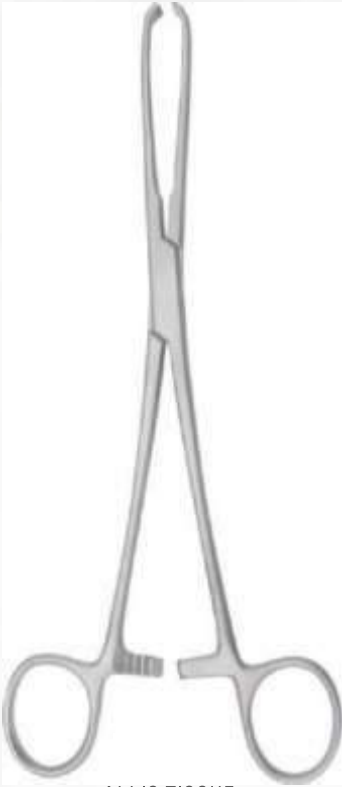

ALLIS TISSUE
GRASPING FORCEPS
STAINLESS STEEL

4", 6", 8"



ALLIS TISSUE
GRASPING FORCEPS
TUNGSTEN CARBIDE

6"

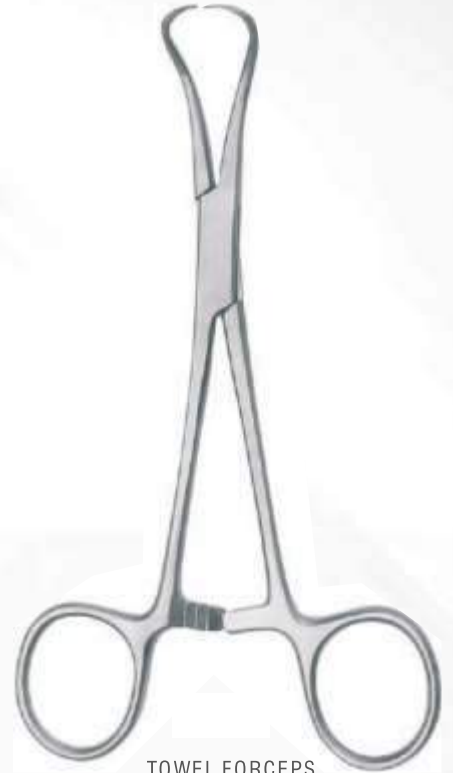

TOWEL FORCEPS
BACKHAUS

4", 6", 8"



BAB COCK
GRASPING FORCEPS
STAINLESS STEEL

4", 6", 8"



BAB COCK
GRASPING FORCEPS
TUNGSTEN CARBIDE

6", 8"



TOWEL CLIP
CROSS ACTION



HYSTERECTOMY
MAINGOTS FORCEPS
STRAIGHT 8"



HYSTERECTOMY
MAINGOTS FORCEPS
CURVED 8"



HYSTERECTOMY
GWILLIAM FORCEPS
STRAIGHT 8"



HYSTERECTOMY
GWILLIAM FORCEPS
CURVED 8"



HYSTERECTOMY CLAMP
DeBAKEY CLAMP



STRAIGHT



CURVED



HALF CURVED



FULL CURVED



KOVAC HYSTERECTOMY
TOOTH CLAMP



STRAIGHT



CURVED



6", 8", 10"

DOYEN INTESTINAL CLAMP



HEANYS HYSTERECTOMY
FORCEPS SINGLE TOOTH
CURVED



HEANYS HYSTERECTOMY
FORCEPS DOUBLE TEETH
CURVED



MIXTURE LIGATURE
RIGHT ANGLED FORCEPS

6", 8", 10"



GREEN
ARMYTAGE
FORCEPS



LAHEY'S
FORCEPS



SPONGE
HOLDING FORCEPS
8", 10"



KELLY
POLYPUS FORCEPS
12"



OVEM FORCEPS



STRAIGHT



CURVED



TENACULUM
DOUBLE TEETH FORCEPS





CHEATLE
JAR



UTERINE VULSELLUM
FORCEPS



CHEATLE FORCEPS



BLADDER
STONE FORCEPS



LISTER SINUS
DRESSING FORCEPS



RENDALLS RENAL
FORCEPS



BLAKE
GALL BLADDER
FORCEPS



PERFORATOR
SIMS FORCEPS



VEIN STRIPPERS



HERNIA
RING FORCEPS



BOWL LIFTING
FORCEPS



MAYO SAFETY PIN
INSTRUMENT HOLDER

12"



DISSECTING FORCEPS
FINE

6", 8"



DISSECTING FORCEPS

5", 6", 7", 8"



DENNIS BROWNE
DISSECTING FORCEPS

8"



RUSSIAN DISSECTING
FORCEPS

6", 8"



GERALD FORCEPS
STRAIGHT NARROW 7"



BROWN FORCEPS
8 x 8 TEETH

6", 8", 10"



ADSON FORCEPS

5", 7", 8"



ADSON BROWN
FORCEPS 5"

5"



ADSON FORCEPS

5", 6"



ADSON FORCEPS
PLAIN- 5"
Fine

T.C



ADSON FORCEPS
PLAIN- 5"
Fine

TITANIUM



CUSHING FORCEPS SEMI SHARP
DISSECTING END GUTSCH HANDLE

7"



CROW INSULATED FORCEPS
9" STRAIGHT



JANSEN BAYNOT
FORCEPS PLANI

6", 7", 8"



MAXWELL FORCEPS
9" CURVED



6", 7", 8"
JANSEN BAYNOT
FORCEPS PLANI



CASTROVIEJO
FORCEPS with PLAT FORM



SUTURE TYING
FORCEPS CURVED



MCPHERSON TYING FORCEPS
FLAT HANDLE



NELSON TISSUE
FORCEPS



6", 8"

MICRO JEWELLERS
FORCEPS



MICRO FORCEPS ROUND HANDLE
PLATFORM TIP

6", 8"



GREEN FIXATION
FORCEPS
OP-80096



MICRO FORCEPS FLAT HANDLE
PLATFORM TIP

6", 8"

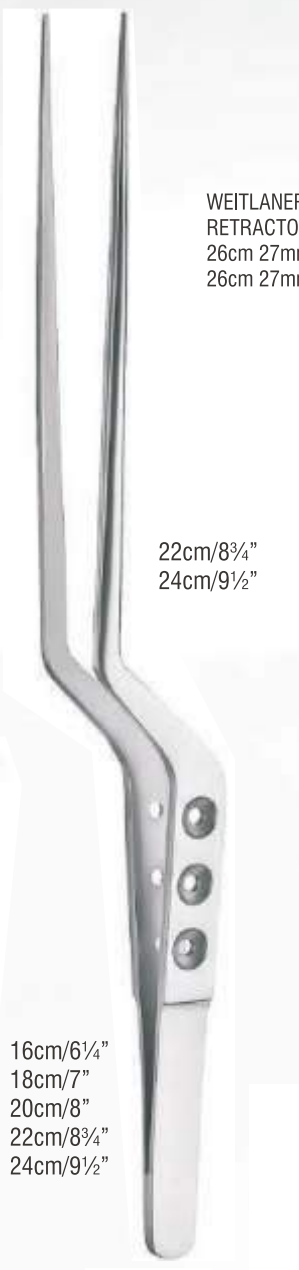

WEITLANER STRAIGHT
RETRACTOR
26cm 27mm 5x6
26cm 27mm 5x6

22cm/8³/₄"
24cm/9¹/₂"



WEITLANER STRAIGHT
RETRACTOR
13cm 18mm 3x4
16cm 18mm 3x4
20cm 21mm 3x4
25cm 27mm 3x4
20cm 21mm 4x5



RETRACTOR
RIGHT BLADE 42mm,
LEFT BLADE 22mm
DEEP
29cm 22/42mm
6x6 PRONGS SEMI
SHARP



Self-retaining retractors



16cm/6¹/₄"
18cm/7"
20cm/8"
22cm/8³/₄"
24cm/9¹/₂"

YASARGIL
MICRO FORCE



MOLLISOM
RETRACTOR
14cm, 18mm 3x3
14cm, 18mm 3x3
14cm, 18mm 3x4
14cm, 18mm 3x4
16.5cm, 18mm 3x4
16.5cm, 18mm 3x4



MAYO ADSON
LEMOTOMY
RETRACTOR
31cm, 27mm 4x5
31cm, 27mm 4x5

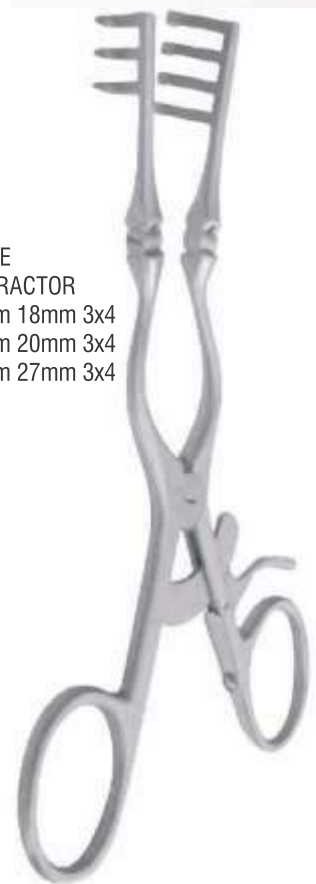

CONE
RETRACTOR
16cm 18mm 3x4
20cm 20mm 3x4
26cm 27mm 3x4

LANGENBECK
RETRACTOR
SMALL

25CM x 6MM
35CM x 15MM



LANGENBECK
RETRACTOR
LARGE

45CM x 20MM
65CM x 25MM
75CM x 25MM
90CM x 25MM



LANGENBECK RETRACTOR
WITH FIBER OPTIC LIGHT CARRIERS
ALONG WITH SUCTION

45CM x 20MM
75CM x 25MM



DOYEN RETRACTOR

1"
1½"
2"
2½"
3"
3½"
4"



DOYEN RETRACTOR
WITH FIBER OPTIC
LIGHT CARRIERS

2½"



KELLY RETRACTOR

2"X1½"
2½"X2"
3"X2½"
3½"X2¼"



VOLKMANN RETRACTOR SHARP

VOLKMANN RETRACTOR BLUNT



DEAVERS RETRACTOR

1/2" x 6"

3/4" x 8"

1" x 12"



DEAVERS RETRACTOR ADULT

1 1/2" x 12"

2" x 12"

2 1/2" x 12"



1 1/2" x 12"
1" x 12"

DEAVERS RETRACTOR WITH FIBER OPTIC LIGHT CARRIER ADULT



45° ANGLED
90° ANGLED

LOVER NERVE ROOT RETRACTOR 22cm 5mm TIP WIDTH



MORRIS RETRACTOR

1 1/2"
2"
2 1/2"
3"



MORRIS RETRACTOR WITH FIBER OPTIC LIGHT CARRIER

2 1/2"



KELLY'S RETRACTOR



CZERNY RETRACTOR

6", 8"



S SHAPE RETRACTOR
3/8" WIDE

6", 8"

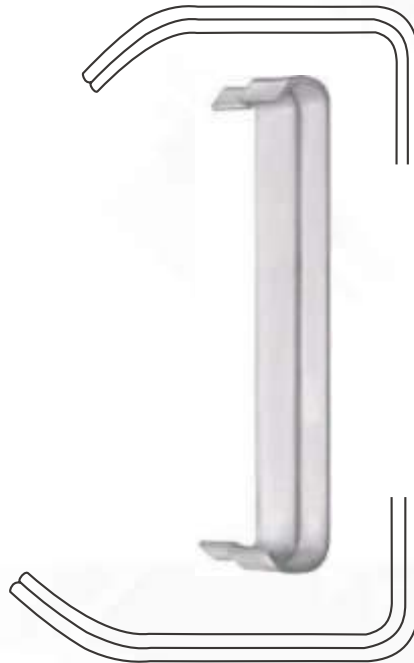

LANE'S RETRACTOR
SET OF 2



ROUX RETRACTOR
SET OF 3



DAVIS MALLEABLE RETRACTOR

6MM 18MM
8MM 20MM
10 MM 22MM
12MM 14MM
16MM 25MM



THYROID DISSECTOR



DISSECTOR
McDONALD



JOLLS THYROID
RETRACTOR



COTTLE
RETRACTOR
BLUNT



COTTLE
RETRACTOR
SHARP



COTTLE UPPER
RETRACTOR



JOSEPH
RETRACTOR
FINE SHARP



GILLIES
SKIN HOOK



COTTLE UPPER
TEFION COATED
RETRACTOR



ROLLET
RETRACTOR
4 SHARP PRONGS



KILNER
RETRACTOR



RAGNELL
RETRACTOR

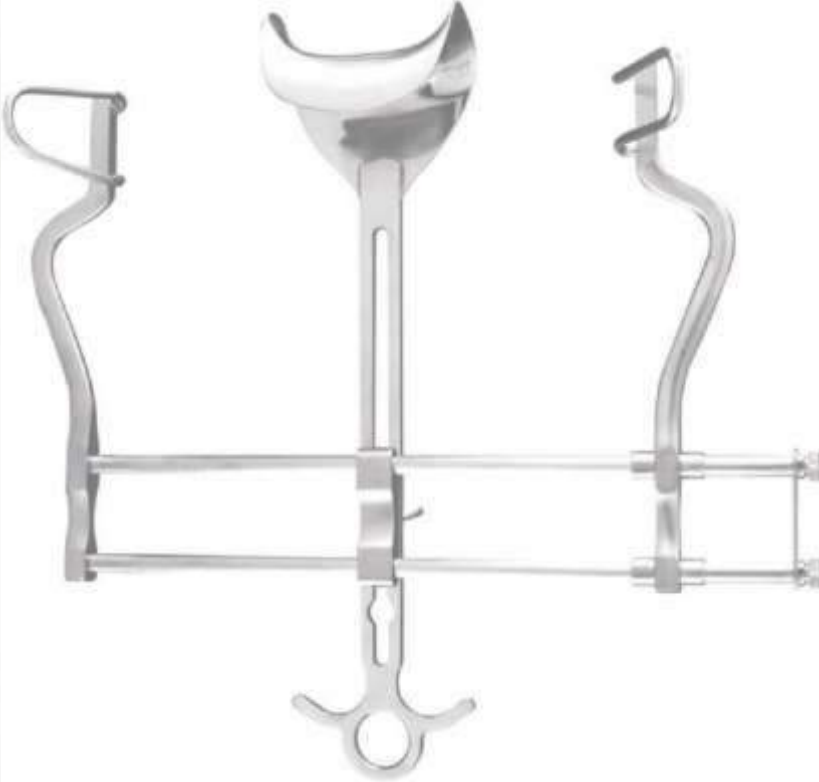

(BALFOUR) ABDOMINAL
SELF - REATINING RETRACOTR



POZZI SELF-RETAINING RETRACTOR
WITH THREE BLADE

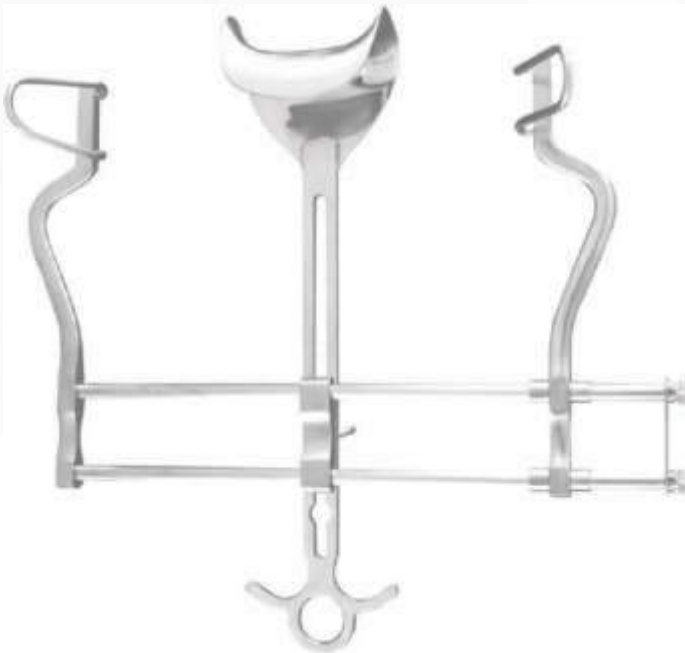

(BALFOUR) ABDOMINAL
SELF - REATINING RETRACTOR
CHILD



PARKS ANAL
RETRACTOR



PENILE CLAMP

DIRECTOR WITH ANEURYSM NEEDLE



MILLIAN BLADDER RETRACTOR



THOMSON WALKER BLADDER RETRACTOR

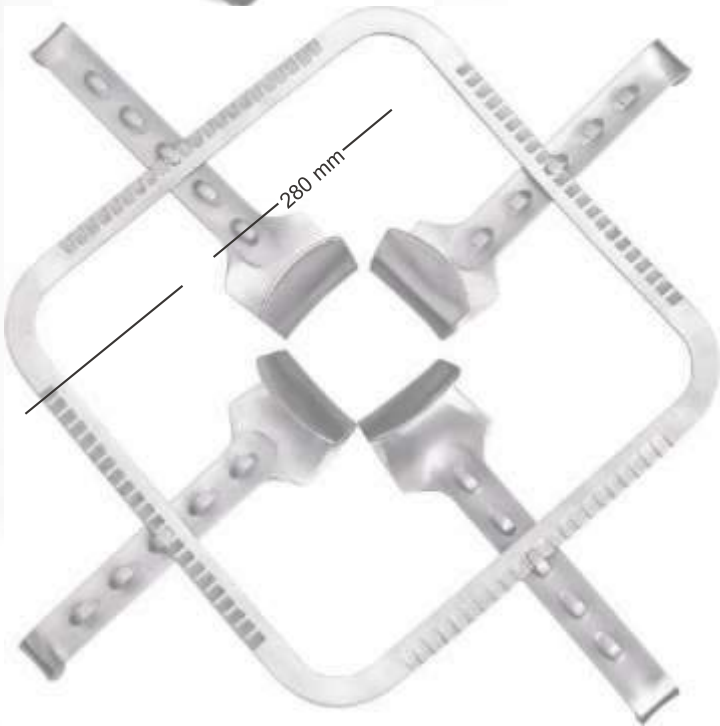

ABDOMINAL RETRACTOR
KIRSHNER SET OF 4 BLADES

ABDOMINAL RETRACTOR
KIRSHNER OVAL SET OF 6 BLADES

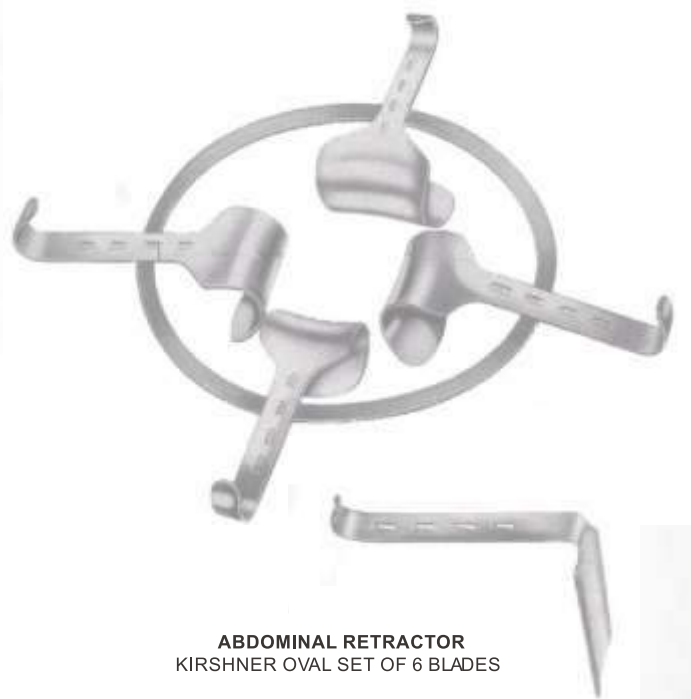



PLAIN
15CM X 30MM



WITH TEETH
15CM X 30MM

TEBBETTS RETRACTOR
WITH FIBER OPTIC ILLUMINATION
& SUCTION TUBE



FREER
ELEVATOR BROAD



DISSECTOR
WITH SUCCER



RASPATORIEN
ROUND

8mm, 9mm, 10mm



RASPATORIEN
SHARP

4mm, 5mm



COTTLE MCKENTY
ELEVATOR



COHEN
ELEVATOR



WILLIGER
RASPTORIEN

3mm, 5mm



OBWEGESER
RASAPTORIEN

6mm, 7mm
9mm, 11mm



SMALL
MEDIUM
LARGE
EXTRA LARGE

KELLY'S RECTAL SPECULUM



SMALL
MEDIUM
LARGE
EXTRA LARGE

**KELLY'S RECTAL SPECULUM
WITH FIBER OPTIC CARRIER**

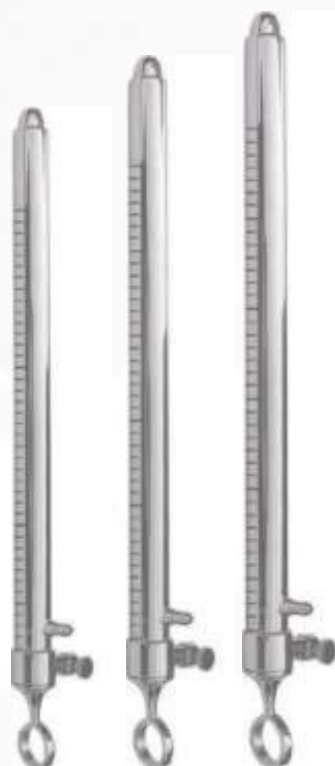

SMALL MEDIUM LARGE



**SIGMOID SCOPE WITH FIBER OPTIC LIGHT
CARRIER**

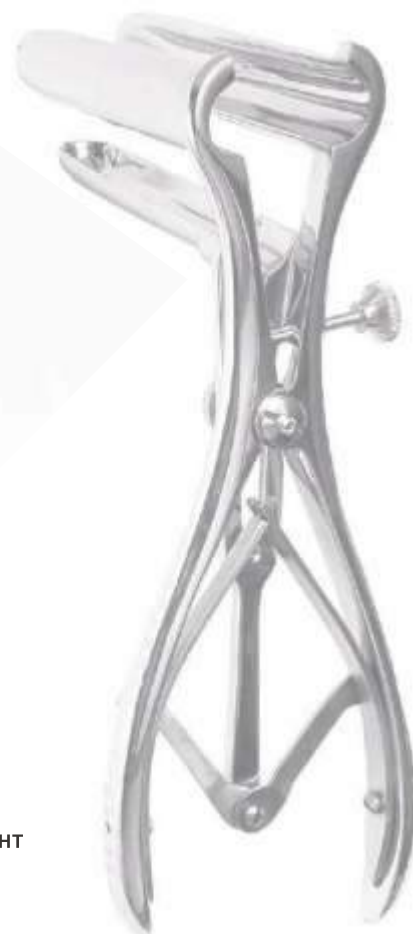

**MATHIEU RECTAL SPECULUM
TRIVALVE SELF RETAINING**

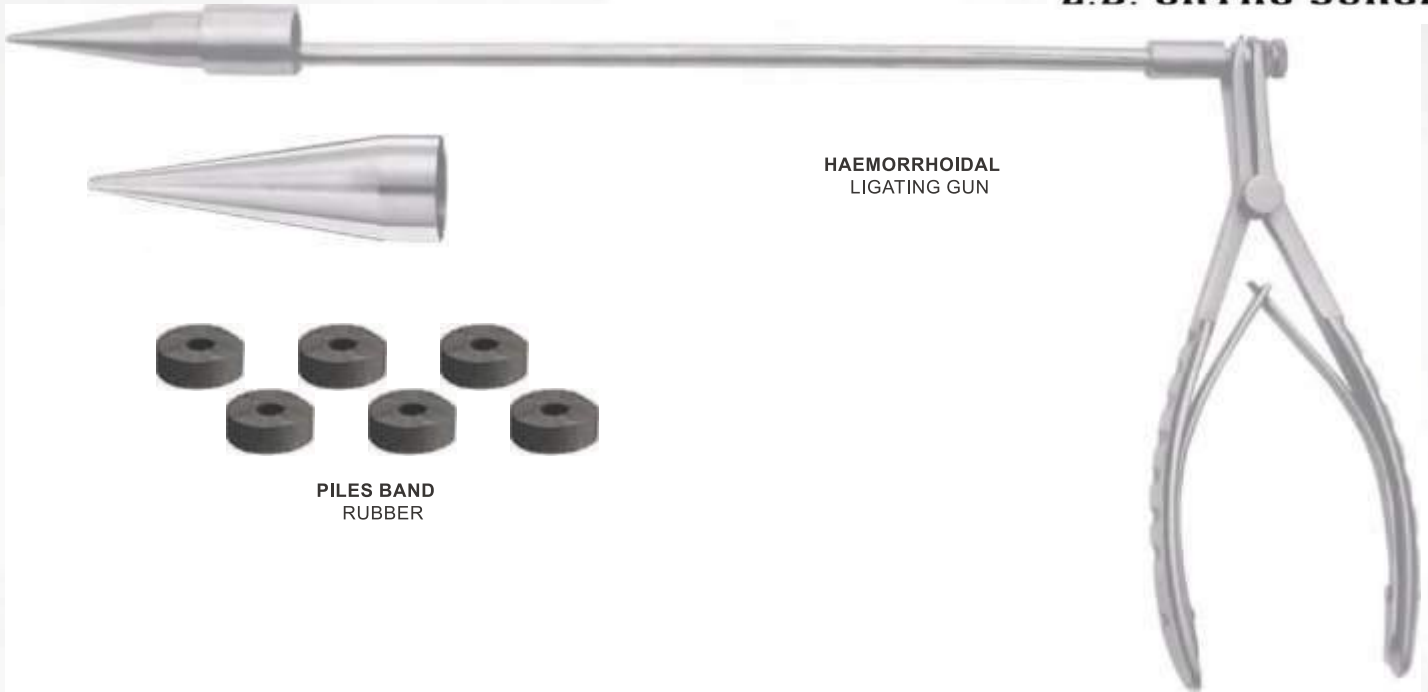

HAEMORRHOIDAL
LIGATING GUN



PILES BAND
RUBBER



HAEMORRHOIDAL LIGATING
FORCEPS



HAEMORRHOIDAL LIGATING
WITH SUCTION

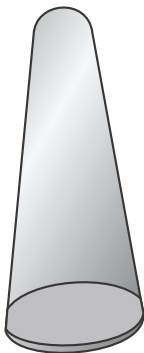

NO.1
NO.2
NO.3
NO.4

ST. MARKS RECTAL DILATOR



**UTERINE DRESSING
FORCEPS**



**UTERINE VULSELLUM
FORCEPS**



**UTERINE TENACULUM
SINGLE TOOTH FORCEPS**



**UTERINE TENACULUM
SINGLE TOOTH FORCEPS,**



KOGAN 9.5" (24CM) CALIBRATE

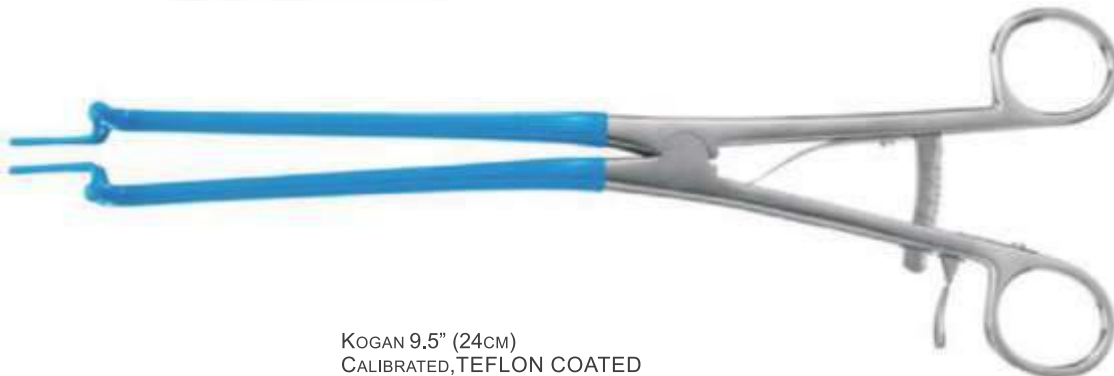

**KOGAN 9.5" (24CM)
CALIBRATED, TEFLON COATED**



HOOK

10''-25.5 CM

HOOK WITH 3 PRONGS

10''-25.5 CM



UTERINE MANIPULATOR
RING HANDLE

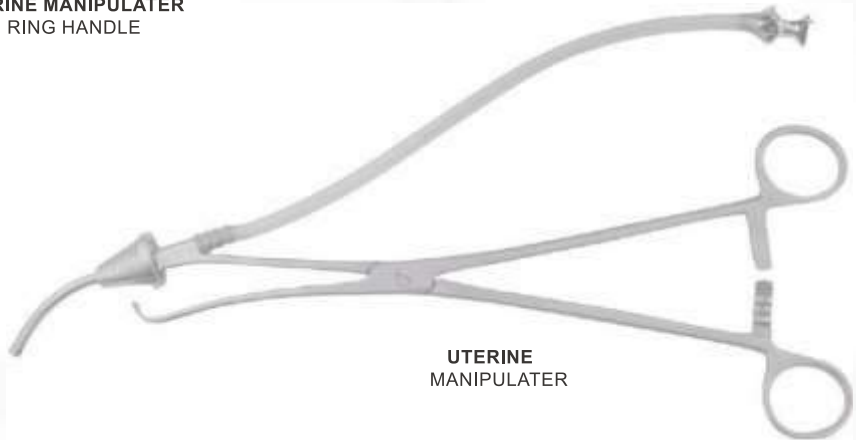

UTERINE
MANIPULATOR

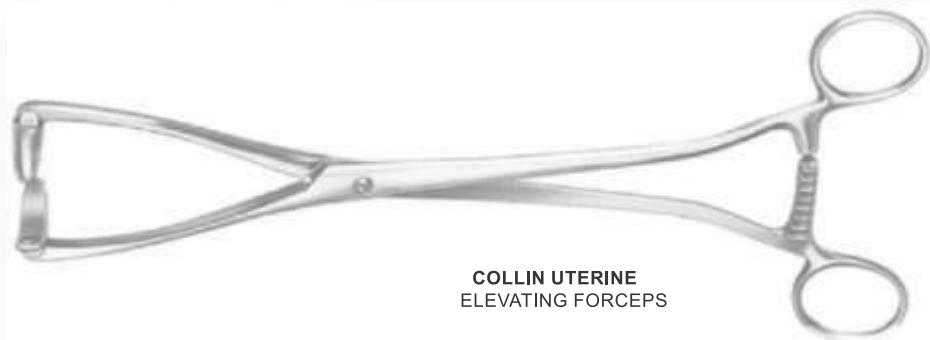

COLLIN UTERINE
ELEVATING FORCEPS



BURKE
BIOPSY PUNCH, 8.5''



EPPENDORF
ALEXAI
BIOPSY PUNCH, 8''



CERVICAL BIOPSY
PUNCH



LONDON
VAGINAL RETRACTOR
RIGHT ANGLED



MIDWIFERY FORCEPS
SIMPSON



WRINGLE
FORCEPS

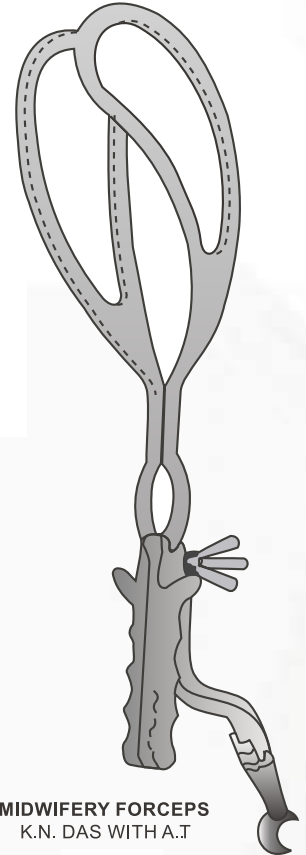

MIDWIFERY FORCEPS
K.N. DAS WITH A.T



6MM, 9MM, 12MM

SIMS UTERINE CURETTE , SEMI SHARP 10"-25.5CM



6X5MM, 9X6MM, 12X9MM

SIMS UTERINE CURETTE , SEMI SHARP 10"-25.5CM
DOUBLE ENDED



CUSCO SPECULUM WITH FIBER

SMALL 22X80MM
MEDIUM 25X100MM
LARGE 27X105MM

CUSCO SPECULUM WITH FIBER

SMALL 22X80MM
MEDIUM 25X100MM
LARGE 27X105MM



GRAVES SPECULUM

SMALL 20X75MM
MEDIUM 35X95MM
LARGE 35X115MM



SMALL 20X75MM
MEDIUM 35X95MM
LARGE 35X115MM

GRAVES SPECULUM



KRISTELLER VAGINAL SPECULUM

SMALL
MEDIUM
LARGE



SIMS SPECULUM

SMALL
MEDIUM
LARGE



SMALL

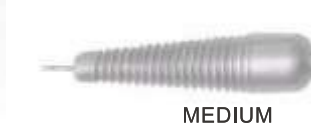

MEDIUM



LARGE
7552



HYSTO-GRAPHI CANNULAS
WITH LOCK



SMALL



MEDIUM



LARGE



HYSTO-GRAPHI CANNULAS
WITHOUT LOCK



ENDOMETRIAL BIOPSY CURETTE NOVAK



RANDALLS ENDOMETRIAL BIOPSY CURETTE



GRADUATED UTERINE SOUND



INTERIOR VAGINAL WALL RETRACTOR



MYMO-SCREW



FOETAL STETHOSCOPI



HEGAR DILATORS SET OF 8



HEGAR DILATORS GRADUATED FINE 1/2MM SET OF 10



HEGAR DILATORS SINGLE ENDED SET OF 16



**GILLIES
OSTEOTOME**

STRAIGHT
2mm, 3mm
4mm, 6mm
8mm, 10mm

CURVED
2mm, 3mm
4mm, 6mm
8mm, 10mm



**GILLIES
CHISEL**

STRAIGHT
2mm, 3mm
4mm, 6mm
8mm, 10mm



**GILLIES
GOUGE**

SIZE
2mm, 3mm, 4mm, 6mm
8mm, 10mm



**LAMPERT CURETTE
STRAIGHT/ANGLED 21cm/8 1/4"**

1.0mm	3.0mm
1.5mm	3.5mm
2.0mm	4.0mm
2.5mm	4.5mm



**VOLKMANN DOUBLE
ENDED CURETTE 22CM**

1.0mm	3.0mm
1.5mm	3.5mm
2.0mm	4.0mm
2.5mm	4.5mm



TOFFEE MALLET



**STILLE OSTEOTOME
20cm 8" LENGTH**

6MM
8MM
10MM
12MM
14MM
18MM
22MM



**SMITH OSTEOTOME
HEAVY HANDLE
20cm 8" LENGTH**

10MM
15MM
20MM
25MM
30MM



**LAMBOTTE GOUGE
25cm 9 1/4" LENGTH**

6mm
9mm
13mm
16mm
19mm
25mm
32mm



**MALLET WITH FERROZELL
HANDLE
HEAD SIZE 35mm Ø
WEIGHT 500g/20oz**



**PERCUSSOR HAMMER
T-SHAPE**



PERCUSSOR HAMMER



WIRE CUTTER
19 cm – 7 1/2
23 cm – 9



HENNING SOREDER 27CM-10 3/4'
27CM-10 3/4'



Ralk
for twist drills up to Ø 7 mm,
for wires up to Ø4 mm



**Engel
Plaster saw**
15 cm – 6"



Satterlee
29 cm – 11 3/8"

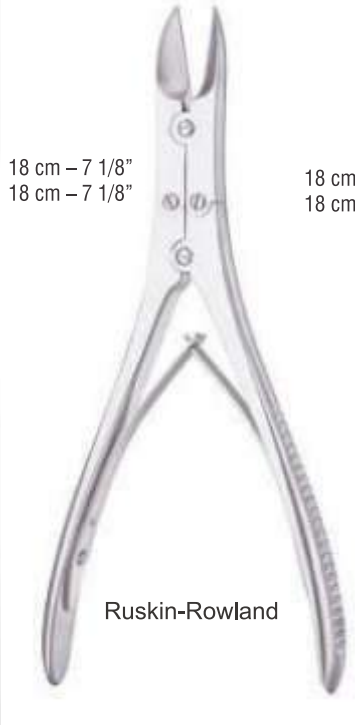

18 cm – 7 1/8"
18 cm – 7 1/8"

Ruskin-Rowland

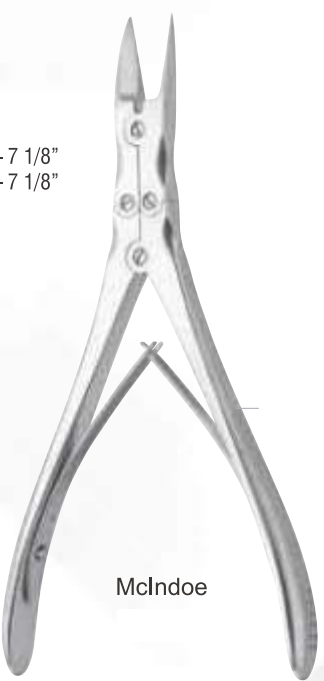

18 cm – 7 1/8"
18 cm – 7 1/8"

McIndoe



14 cm – 5 1/2"
17 cm – 6 3/4"
20 cm – 8"
22 cm – 8 3/4"

Liston



15 cm – 6"

Liston-mini



Fergusson
26 cm – 10 1/4"



24 cm – 9 1/2"
26 cm – 10 1/4"
28 cm – 11"

Verbrugge



Verbrugge



13,5 cm – 5 3/8"

self-centering



A
63mm, 61mm

B
43mm, 61mm

Burford
with 2 pairs of detachable blades



DeBakey
with 3 pairs of detachable blades



Burford
with 2 pairs of detachable blades



Cooley

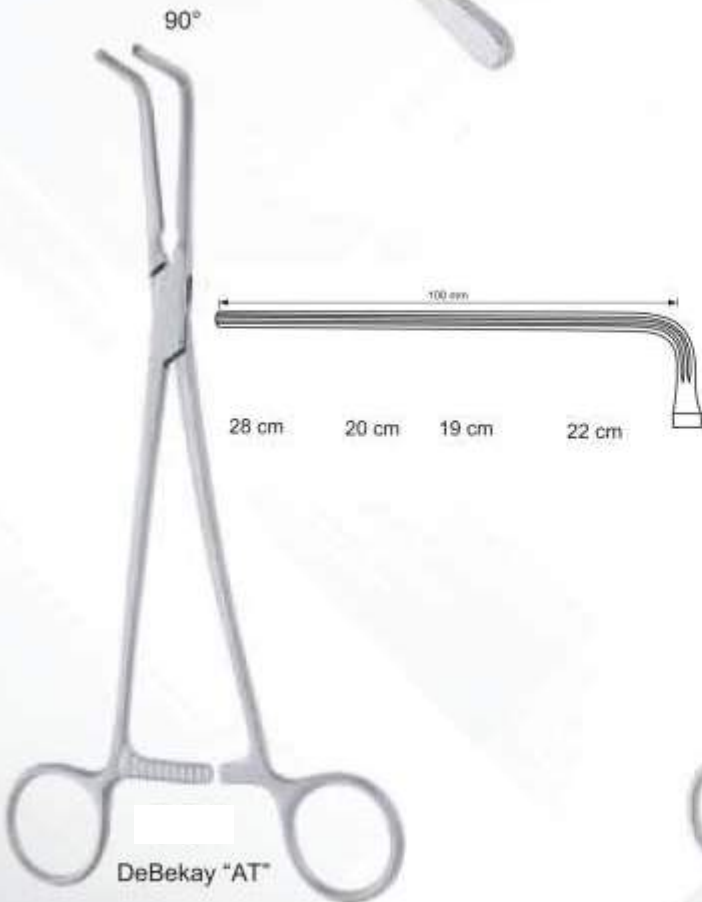



15 mm
20 mm
25 mm

Neonatal

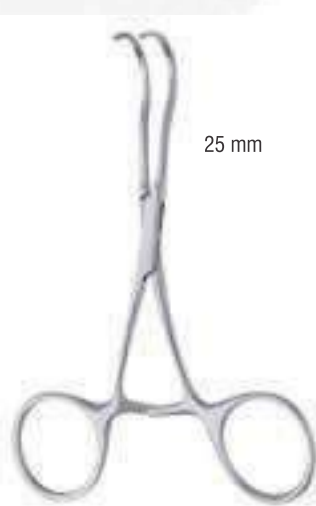

clai

25 mm

Neonatal



Cooley "AT"



Duval
15 mm, 20 mm



DEBAKEY VASCULAR
FORCEPS

6", 7", 8"



MICRO FORCEPS
ROUND HANDLE

7", 8"



ALLISON LUNG
RETRACTOR

80mm 90mm 45mm
20mm 30mm 125mm
105mm 68mm



Debakey Bulldog Clamps



Glover Bulldog Clamps
Closing Pressure Adjustable

50mm
20mm
68mm
30mm
85mm
40mm
105mm
56mm

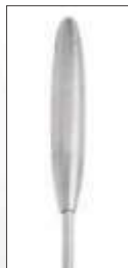

DeBakey Vessel Dilator
19cm/ 7 1/2" Length
Malleable Shaft

0.5mm	3.5mm
1.0mm	4.0mm
1.5mm	4.5mm
2.0mm	5.0mm
2.5mm	7.0mm
3.0mm	9.0mm



RIB SPREADERS
APPROXIMATOR



LANES TWIN
INTESTINAL CLAMPS
CURVED

145MM
110MM
70MM

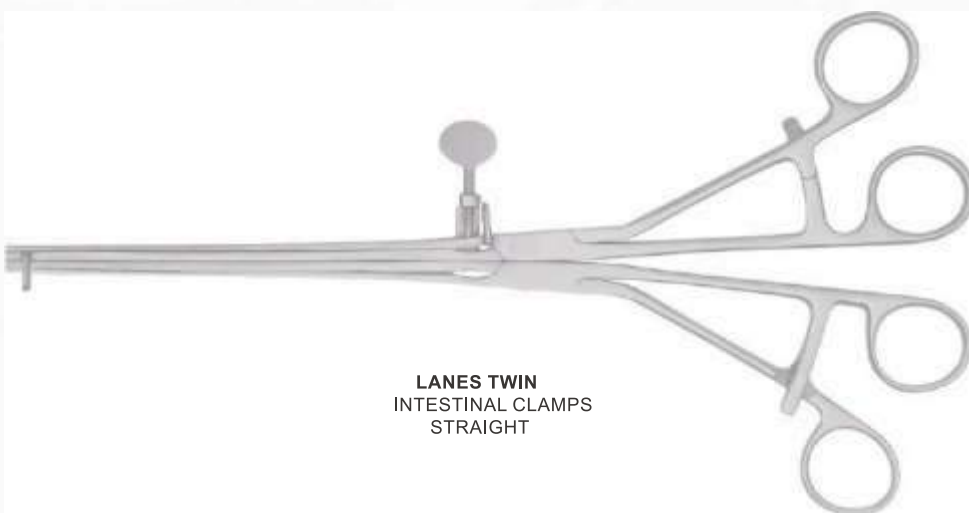

LANES TWIN
INTESTINAL CLAMPS
STRAIGHT

145MM
110MM
70MM



PAYRS CRUSHING
INTESTINAL CLAMP



**BLADDER
NECK SPREADER**



**SUPRAPUBIC TROCARS
& CANNULA**



NO.1
NO.2
NO.3
NO.4

FISTULA DIRECTORS



CATHETER INTRODUCER



**LISTER UREATHAL DILATOR
SET OF 12**



**CLUTTON UREATHAL
DILATOR SET OF 12**



**MALE CATHETER
SET OF 10**



**FEMALE
CATHETER**

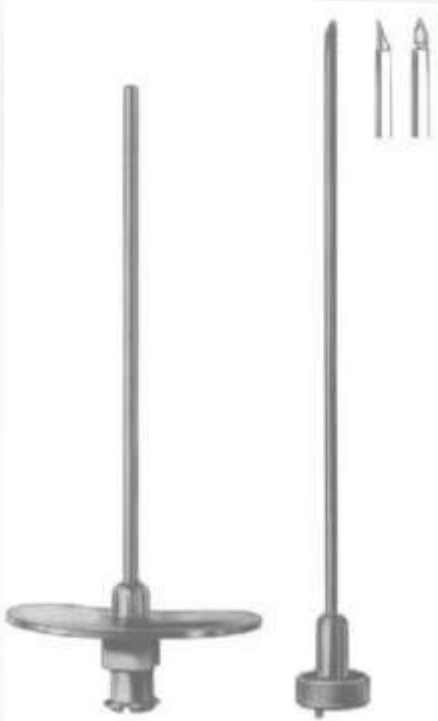

MEGHINI RENAL BIOPSY NEEDLE



SILVER BIOPSY NEEDLE



PILE SYRINGE NEEDLE STRAIGHT



PILE SYRINGE NEEDLE CURVED



SPINAL (LP) NEEDLE

12, 14, 16
18, 20, 22
24



LUER LOCK



LICHTWITZ

Ø 1,5 mm
Ø 1,8 mm
Ø 2,0 mm



LICHTWITZ-EICKEN

Ø 1,5 mm
Ø 1,8 mm
Ø 2,0 mm



VOGEL

Ø 1,5 mm
Ø 1,8 mm
Ø 2,0 mm



BONE MARROW trephine needle

16
18
20



STERNAL Ø 1.8 mm PUNCTURE NEEDLE



Pooler Suction Tube
24cm/9 1/2" Length 10mm Ø
Curved Mount



Yankauer Suction Tube
30.5cm/12" Length



M.T.P. CANNULA METAL
SET OF 6

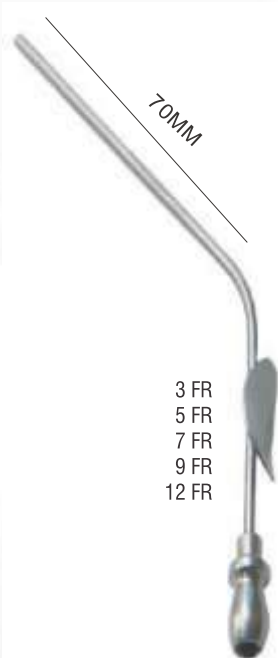

BARRON SUCTION
TUBE

3 FR
5 FR
7 FR
9 FR
12 FR

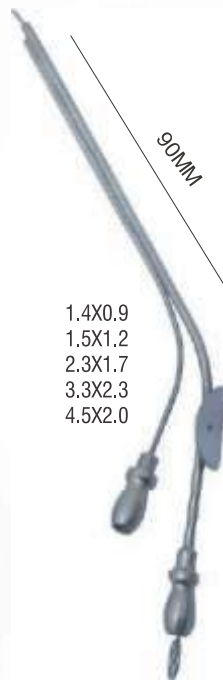

SUCTION IRRIGATION TUBE
WITH CHANNEL

1.4X0.9
1.5X1.2
2.3X1.7
3.3X2.3
4.5X2.0



FRAZIER SUCTION
TUBES, BALL END, L:8"

2.0 MM
2.7 MM
3.3 MM
4.0 MM



LONG HANDLE

B.P. Handle 3



LONG HANDLE

B.P. Handle 4



B.P. Handle 7



ROUND. Handle 3



B.P. Handle Curved



P-12003- VERTICAL CUTTING NO-3
N-10660- HORIZONTAL CUTTING NO-3
N-10683- VERTICAL CUTTING NO-4



ROUND HANDLE



L.B. ORTHO SURGICAL



**WATSON SKIN
GRAFTING HANDLE**

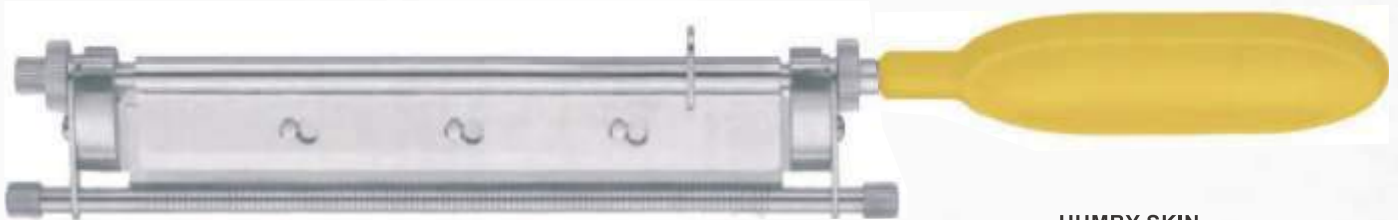

**HUMBY SKIN
GRAFTING HANDLE**



**SKIN GRAFTING
BLADE**



**SILVER SKIN
GRAFTING KNIFE
FOR SVAING BLADES USE**



**BIPOLAR COAGULATION
FORCEPS BAYONET TIP-1M**



**BIPOLAR
COAGULATION
FORCEPS BAYONET TIP-1MM**



**BIPOLAR
COAGULATION
FORCEPS BAYONET TIP-1MM
WITH SUCTION**



**BIPOLAR
COAGULATION TIP-1MM
FORCEPS (ST.)**



**BIPOLAR
COAGULATION TIP-1MM
FORCEPS (ST.)**



**BIPOLAR
COAGULATION
FORCEPS CURVEDTI P-1MM
WITH TWO PINS TIP-1MM**



**BIPOLAR COAGULATION
FORCEPS CURVED
WITH TWO PINS TIP-1MM**

**COAGULATION
FORCEPS CURVEDTI P-1M**



**BIPOLAR
COAGULATION
FORCEPS CURVEDTI P-1MM
WITH SUCTION**



**BIPOLAR
COAGULATION
FORCEPS CURVEDTI P-1MM
WITH TWO PINS**

Ped Laryngoscope



Adult Laryngoscope



3MM, 5MM

BALL PROBE
WORKING LENGTH- 140MM



LOOPS
WORKING LENGTH- 140MM
1.5X1.5MM, 2.0X1.5MM
2.0X1.5MM, 2.0X2.0MM



NEEDLE
WORKING LENGTH- 35MM



PENCIL CABLE



CABLE



ARTERY FORCEPS CURVED

7"



TURNER WARWICK SCISSORS CURVED

7"



BIPOLAR CABLE AFTL PIN



MONOPOLAR CABLE



ARTERY FORCEPS STRAIGHT

7"



TURNER WARWICK SCISSORS STRAIGHT

7"



BIPOLAR CABLE TWO PIN